

Clausing **SURFACE GRINDERS**

600 Group

*Celebrating Over 105 Years
in the Machine Tool Business*

*A Line of Precision Low-cost,
High Performance Surface Grinders*



- Precision Manual Surface Grinders
- Precision Hydraulic Surface Grinders
- Precision Automatic Surface Grinders

Clausing Precision 618 & 818 Series Surface Grinders

- Manual Surface Grinders
- Longitudinal Hydraulics and Motorized Crossfeed Surface Grinders (2A Models)
- Longitudinal Hydraulics, Motorized Crossfeed and Motorized Rapid Up/Down Surface Grinders (3A Models)



Model CSG3A818 shown with optional dresser and coolant/dust system

Outstanding Features...

■ High Precision Cartridge Spindle

High precision cartridge type spindle is supported by 2 preloaded precision angular contact ball bearings & one NN type roller bearing and driven by V3 class motor that allows highly accurate grinding performance. (CSG618/818 series driven by 2HP motor).

■ Anti-wear Guide Ways

The saddle rests on precision hand-scraped double V ways & the table rests on precision hand-scraped V & flat ways which are coated with 'TURCITE-B'. These guide ways are equipped with auto lubrication to resist wear for lasting accuracy & dampening. CSG618/818 hand feed grinders have ballways between table and saddle.

■ Rigid Cast Construction

Machines are constructed of high grade cast iron with heavy walls & reinforced ribs to provide excellent rigidity and dampening.

■ Enlarged Column & Base

Enlarged column & base create high stability & rigidity. The maximum height is 18" (460mm) from table surface to the center line of spindle.

■ Auto Lube System

Automatic lubrication system is supplied as standard to ensure sufficient lubrication to lead-screws & guideways for greater longevity.

■ Timing Belt Table Drive

Handfeed models (CSG618/818 only) use a timing belt for the table drive which has enclosed high tensile steel cores that ensure more smooth table movement and longevity. The table handwheel can be indexed to 9 different positions, without backlash, for more convenient operation.

■ Longitudinal & Cross Drive

For all models, except CSG618 & 818 handfeed, the longitudinal movement is driven by a hydraulic system; On 2A and 3A series, the cross movement is driven by motor for more accurate increment feeding.

2A: Longitudinal Hydraulics and Motorized Crossfeed

3A: Longitudinal Hydraulics, Motorized Crossfeed and Motorized Rapid Up/Down

Specifications

Model	CSG618H	CSG2A618	CSG3A618	CSG818H	CSG2A818	CSG2A818
Table Size	6" x 18" (152 x 460mm)	6" x 18" (152 x 460mm)	6" x 18" (152 x 460mm)	8" x 18" (203 x 460mm)	8" x 18" (203 x 460mm)	8" x 18" (203 x 460mm)
Max. grinding length (longitudinal)	18.9" (480mm)	18.9" (480mm)	18.9" (480mm)	18.9" (480mm)	18.9" (480mm)	18.9" (480mm)
Max. grinding width (crosswise)	7" (178mm)	7" (178mm)	7" (178mm)	8.9" (228mm)	8.9" (228mm)	8.9" (228mm)
Max. distance from table surface to spindle centerline (standard column)	18" (460mm)	18" (460mm)	18" (460mm)	18" (460mm)	18" (460mm)	18" (460mm)
Standard magnetic chuck size	6" x 18" (150 x 450mm)	6" x 18" (150 x 450mm)	6" x 18" (150 x 450mm)	8" x 18" (200 x 450mm)	8" x 18" (200 x 450mm)	8" x 18" (200 x 450mm)
Longitudinal movement of table						
Max. travel (hydraulic)	-	18.9" (480mm)	18.9" (480mm)	-	18.9" (480mm)	18.9" (480mm)
Max. travel (manual)	20" (510mm)	20" (510mm)	20" (510mm)	20" (510mm)	20" (510mm)	20" (510mm)
Table speed infinitely variable	-	196"-1102"/min. (5-28 m/min.)	196"-1102"/min. (5-28m/min.)	-	196"-984"/min. (5-25 m/min.)	196"-984"/min. (5-25 m/min.)
	-			-		
Crossfeed transverse travel						
Auto transverse increment	-	.04" - .4"(1-10mm)	.04" - .4"(1-10mm)	-	.04" - .4"(1-10mm)	.04" - .4"(1-10mm)
Max. auto transverse travel	-	7" (180mm)	7" (180mm)	-	9.25" (235mm)	9.25" (235mm)
Max. manual transverse travel	7.68" (195mm)	7.68" (195mm)	7.68" (195mm)	9.84" (250mm)	9.84" (250mm)	9.84" (250mm)
Handwheel per revolution	0.2" (5mm)	0.2" (5mm)	0.2" (5mm)	0.2" (5mm)	0.2" (5mm)	0.2" (5mm)
Handwheel per graduation	0.0005" (.0127mm)	0.0005" (.0127mm)	0.0005" (.0127mm)	0.0005" (.0127mm)	0.0005" (.0127mm)	0.0005" (.0127mm)
Wheelhead vertical downfeed						
Rapid Travel Approx.	-	-	10" (250mm)/min	-	-	10" (250mm)/min
Handwheel per revolution	0.05" (1mm)	0.05" (1mm)	0.05" (1mm)	0.05" (1mm)	0.05" (1mm)	0.05" (1mm)
Handwheel per graduation	0.0002" (.005mm)	0.0001" (.0025mm)	0.0001" (.0025mm)	0.0002" (.005mm)	0.0001" (.0025mm)	0.0001" (.0025mm)
Grinding spindle drive						
Speed (rpm)	3450	3450	3450	3450	3450	3450
Power rating	2 Hp (1.5kw)	2 Hp (1.5kw)	2 Hp (1.5kw)	2 Hp (1.5kw)	2 Hp (1.5kw)	2 Hp (1.5kw)
Standard grinding wheel						
Diameter	8" (203mm)	8" (203mm)	8" (203mm)	8" (203mm)	8" (203mm)	8" (203mm)
Width	.5"-.75"(13-19mm)	.5"-.75"(13-19mm)	.5"-.75"(13-19mm)	.5"-.75"(13-19mm)	.5"-.75"(13-19mm)	.5"-.75"(13-19mm)
Bore	1.25" (31.75mm)	1.25" (31.75mm)	1.25" (31.75mm)	1.25" (31.75mm)	1.25" (31.75mm)	1.25" (31.75mm)
Hydraulic motor (power rating)	-	1 Hp x 6P	1 Hp x 6P	-	1 Hp x 6P	1 Hp x 6P
Crossfeed motor (power rating)	-	40W x 6P	40W x 6P	-	40W x 6P	40W x 6P
Elevating motor (power rating)	-	-	40W x 4P	-	-	40W x 4P
Total space required (LxWxH)	71.3" x 44.6" x 65.4" (1810x1133x1660mm)	71.3" x 44.6" x 65.4" (1810x1133x1660mm)	71.3" x 44.6" x 65.4" (1810x1133x1660mm)	71.3" x 50.6" x 66.1" (1810x1285x1680mm)	71.3" x 50.6" x 66.1" (1810x1285x1680mm)	71.3" x 50.6" x 66.1" (1810x1285x1680mm)
Weight						
Net weight	1,587 lbs (720kg)	1,808 lbs (820kg)	1,874 lbs (850kg)	2,332 lbs (1060kg)	2,579 lbs (1170kg)	2,657 lbs (1205kg)
Gross weight	1,873 lbs (850kg)	2,138 lbs (970kg)	2,204 lbs (1000kg)	2,662 lbs (1210kg)	2,954 lbs (1340kg)	3,031 lbs (1375kg)
Rated power, approx	2 Hp (1.5 kw)	3 Hp (2.3 kw)	3 Hp (2.3 kw)	2 Hp (1.5 kw)	3 Hp (2.3 kw)	3 Hp (2.3 kw)
Packing dimensions (L x W x H)	77" x 55" x 76" (1940x1400x1930mm)	78" x 56" x 76" (1980x1420x1930mm)	78" x 56" x 76" (1980x1420x1930mm)	76.4" x 55" x 76" (1940x1400x1930mm)	75" x 64" x 76" (1890x1630x1930mm)	75" x 64" x 76" (1890x1630x1930mm)

Machine design and specifications are subject to change without notice.

Clausing Precision 10 - 12 - 16 Series Surface Grinders

- Longitudinal Hydraulics and Motorized Crossfeed Surface Grinders
- Longitudinal Hydraulics, Motorized Crossfeed and Motorized Rapid Up/Down Surface Grinders



Model CSG3A1020 shown with optional dresser and coolant/dust system

Model CSG3A1228 shown with optional paper/coolant system

Outstanding Features...

■ Column

Wide, deep base & honeycomb ribbing are especially suitable for heavy duty grinding.

■ Construction

Table, saddle and base are cast from high grade iron, strongly ribbed.

■ Spindle

Large diameter spindle is supported by four preloaded precision angular contact ball bearings & one NU type Roller bearing for durable, heavy duty operation.

■ Enlarged Column & Base

Enlarged column & base create high stability & rigidity. The maximum height is 18" (460mm) from table surface to the center line of spindle.

■ Slideways

Vertical, cross (double vees) and longitudinal (vee & flat) slideways are coated with Turcite-B, to provide stable movement and durable accuracy.

■ Automatic Continuous Lubrication System

All slideways and screws are fully oiled by automatic continuous lubrication system to minimize wear on slideways & screws.

■ Cross Feed

Ball screw for cross travel, powered by AC motor.

■ Proximity

Has a built-in type (hidden) proximity switch for easy operation.

■ Table Speed Control

Presetable hydraulic table speed control allows operator to pre-set speed rate, enables you to have same speed rate when engaging hydraulic table every time.

2A: Longitudinal Hydraulics and Motorized Crossfeed

3A: Longitudinal Hydraulics, Motorized Crossfeed and Motorized Rapid Up/Down

Specifications

Model	CSG2A1020	CSG3A1020	CSG2A1224	CSG3A1224	CSG3A1228	CSG3A1236	CSG3A1632	CSG3A1640
Table Size	10" x 20" (254 x 508mm)	10" x 20" (254 x 508mm)	11.81" x 23.62" (300 x 600mm)	11.81" x 23.62" (300 x 600mm)	12" x 28" (305 x 712mm)	12" x 36" (305 x 915mm)	16" x 32" (406 x 813mm)	16" x 40" (406 x 1020mm)
Max. grinding length (longitudinal)	20.47" (520mm)	20.47" (520mm)	23.6" (600mm)	23.6" (600mm)	28" (712mm)	36" (915mm)	32" (813mm)	40" (1020mm)
Max. grinding width (crosswise)	11" (280mm)	11" (280mm)	11.81" (300mm)	11.81" (300mm)	13" (330mm)	13" (330mm)	16" (410mm)	16" (410mm)
Max. distance from table surface to spindle centerline (standard column) (optional column)	19.68" (500mm) 23.62" (600mm)	19.68" (500mm) 23.62" (600mm)	23" (585mm) -	23" (585mm) -	24.8" (630mm) 28.35" (720mm)	24.8" (630mm) 28.35" (720mm)	24.8" (630mm) 28.35" (720mm)	24.8" (630mm) 28.35" (720mm)
Standard magnetic chuck size	10" x 20" (250 x 500mm)	10" x 20" (250 x 500mm)	11.81" x 23.63" (300 x 600mm)	11.81" x 23.63" (300 x 600mm)	11.81" x 27.56" (300 x 700mm)	11.81" x 35.43" (300 x 900mm)	15.75" x 31.5" (400 x 800mm)	15.75" x 39.37" (400 x 1000mm)
Longitudinal movement of table								
Max. travel (hydraulic)	22.83" (580mm)	22.83" (580mm)	25.59" (650mm)	25.59" (650mm)	30" (760mm)	37.8" (960mm)	35" (890mm)	41.73" (1060mm)
Max. travel (manual)	24.41" (620mm)	24.41" (620mm)	28.74" (730mm)	28.74" (730mm)	32.68" (830mm)	39.37" (1000mm)	36.61" (930mm)	43.31" (1100mm)
Table speed infinitely variable	196"-984"/min. (5-25 m/min.)	196"-984"/min. (5-25 m/min.)	196"-984"/min. (5-25 m/min.)	196"-984"/min. (5-25 m/min.)	196"-984"/min. (5-25 m/min.)	196"-984"/min. (5-25 m/min.)	196"-984"/min. (5-25 m/min.)	196"-984"/min. (5-25 m/min.)
Crossfeed transverse travel								
Auto transverse increment	.04" - .5"(1-13mm)	.04" - .5"(1-13mm)	.04" - .75"(1-19mm)	.04" - .75"(1-19mm)	.04 - 1"(1-25mm)	.04 - 1"(1-25mm)	.04 - 1"(1-25mm)	.04 - 1"(1-25mm)
Max. auto transverse travel	10.63" (270mm)	10.63" (270mm)	12.2" (310mm)	12.2" (310mm)	13.78" (350mm)	13.78" (350mm)	17" (430mm)	17" (430mm)
Max. manual transverse travel	11.81" (300mm)	11.81" (300mm)	13.39" (340mm)	13.39" (340mm)	15" (380mm)	15" (380mm)	18" (460mm)	18" (460mm)
Handwheel per revolution	0.2" (5mm)	0.2" (5mm)	0.2" (5mm)	0.2" (5mm)	0.2" (5mm)	0.2" (5mm)	0.2" (5mm)	0.2" (5mm)
Handwheel per graduation	0.001" (.025mm)	0.001" (.025mm)	0.001" (.025mm)	0.001" (.025mm)	0.001" (.025mm)	0.001" (.025mm)	0.001" (.025mm)	0.001" (.025mm)
Wheelhead vertical downfeed								
Rapid travel approx.	-	6"(150mm)/min	-	6"(150mm)/min	6"(150mm)/min	6"(150mm)/min	6"(150mm)/min	6"(150mm)/min
Handwheel per revolution	0.04" (1mm)	0.04" (1mm)	0.04" (1mm)	0.04" (1mm)	0.04" (1mm)	0.04" (1mm)	0.04" (1mm)	0.04" (1mm)
Handwheel per graduation	0.0005" (.0127mm)	0.0005" (.0127mm)	0.0005" (.0127mm)	0.0005" (.0127mm)	0.0005" (.0127mm)	0.0005" (.0127mm)	0.0005" (.0127mm)	0.0005" (.0127mm)
Grinding spindle drive								
Speed (rpm)	3450	3450	1750	1750	1750	1750	1750	1750
Power rating	3 Hp	3 Hp	5 Hp	5 Hp	7.5 Hp	7.5 Hp	7.5 Hp	7.5 Hp
Standard grinding wheel								
Diameter	8" (203mm)	8" (203mm)	12" (304mm)	12" (304mm)	14" (355mm)	14" (355mm)	14" (355mm)	14" (355mm)
Width	.75"-.1"(19-25mm)	.75"-.1"(19-25mm)	1.25" (31.75mm)	1.25" (31.75mm)	2" (50mm)	2" (50mm)	2" (50mm)	2" (50mm)
Bore	1.25" (31.75mm)	1.25" (31.75mm)	3" (76.2mm)	3" (76.2mm)	5" (127mm)	5" (127mm)	5" (127mm)	5" (127mm)
Hydraulic motor (power rating)	2 Hp x 6P	2 Hp x 6P	2 Hp x 6P	2 Hp x 6P	3 Hp x 6P	3 Hp x 6P	3 Hp x 6P	3 Hp x 6P
Crossfeed motor (power rating)	80W x 6P	80W x 6P	80W x 6P	80W x 6P	80W x 6P	80W x 6P	80W x 6P	80W x 6P
Elevating motor (power rating)	-	80W x 6P	-	80W x 6P	1/4 Hp x 6P	1/4 Hp x 6P	1/4 Hp x 6P	1/4 Hp x 6P
Total space required (LxWxH)	94.5"x57"x68.9" (2400x1450x1750mm)	94.5"x57.5"x68.9" (2400x1450x1750mm)	106.3"x63"x73" (2700x1600x1850mm)	106.3"x63"x73" (2700x1600x1850mm)	116"x78"x81" (2950x1970x2050mm)	140"x78"x81" (3550x1970x2050mm)	130"x87"x81" (3290x2200x2050mm)	158"x87"x81" (4020x2200x2050mm)
Weight								
Net weight	3,916 lbs (1780kg)	3,990 lbs (1810kg)	4,299 lbs (1950kg)	4,387 lbs (1990kg)	6,659 lbs (3020kg)	7,341 lbs (3330kg)	7,496 lbs (3400kg)	8,818 lbs (4000kg)
Gross weight	4,695 lbs (2130kg)	4,762 lbs (2160kg)	4,960 lbs (2250kg)	5,038 lbs (2290kg)	7,760 lbs (3520kg)	8,157 lbs (3700kg)	8,818 lbs (4000kg)	9,920 lbs (4500kg)
Rated power, approx	5 Hp (3.7 kw)	5.2 Hp (3.9 kw)	7.5 Hp (5.6 kw)	8.25 Hp (6.1kw)	11 Hp (8.2 kw)	11 Hp (8.2 kw)	11 Hp (8.2 kw)	11 Hp (8.2 kw)
Packing dimensions	91"x72"x83" (2290x1830x2100mm)	98"x82"x83" (2480x2060x2100mm)	93"x84"x83" (2340x2130x2100mm)	98"x84"x83" (2480x2140x2100mm)	98"x90"x87" (2500x2290x2220mm)	118"x90"x88" (3000x2290x2220mm)	111"x91"x88" (2800x2290x2220mm)	128"x90"x87" (3250x2290x2220mm)

Machine design and specifications are subject to change without notice.

Clausing Precision ASDIII Automatic Surface Grinders



Model CSG1640ASDIII shown with optional paper/coolant system



Starting Picture

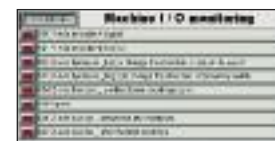

Machine I / O Monitoring

ASDIII Series Operation Panel

Delta PLC Digital Control features a

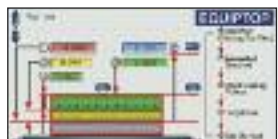

Grinding Size Input



Grinder Condition Input



Alarm Message

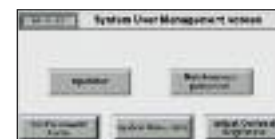

System Data

7.2" color touch screen and is equipped with the exclusive EQUIPTOP picture mode working system, easy to learn and operate.

ASDIII Series Precision Automatic Surface Grinder Features...

- On ASDIII models, you can set the vertical zero point, start point, finish grinding volume, target point and the grinding wheel rise-up point.
- The machine features a simple and clear digital display & touch control panel for easy learning and operation
- Vertical feed powered by dual motors, AC motor for rapid up / down and stepping motor for micro downfeed positioning, slow auto downfeed and slow up / down
- Vertical positioning is displayed on the screen showing present spindle and setting the start point, rough grinding volume, finish grinding volume, downfeed volume for finish grinding, target point, rise up point, intermittent spark-out
- Cross transverse travel powered by DC servo motor, allows step feed and continuous infeed grinding
- The speed of wheel dressing can be adjusted on the control panel
- Wide, deep base and honeycomb ribbed column on 10, 12, 16 & 20 series, designed for heavy-duty grinding
- High quality, ribbed, cast iron table, saddle and base
- All slideways and screws are fully oiled by an automatic continuous lubrication system to minimize wear on slideways & screws
- High Grade Anti-Wear Slideways... The saddle rides on precision, hand-scraped double V ways, and the table rides on precision hand-scraped V and flat ways coated with "TURCITE-B".
- Precision spindle cartridge, supported by preloaded precision angular contact ball bearings and one NN type roller bearing on 618 & 818 models
- Presettable hydraulic table speed control allows operator to pre-set speed rate, so you can have the same speed rate every time the hydraulic table is engaged (10, 12, 16 series)
- Ballscrew for cross travel, powered by DC servo motor

Specifications

Model	CSG818ASDIII	CSG1020ASDIII	CSG1224ASDIII	CSG1228ASDIII	CSG1236ASDIII	CSG1632ASDIII	CSG1640ASDIII	CSG2040ASDIII
Table Size	8" x 18" (203 x 460mm)	10" x 20" (254 x 508mm)	12" x 24" (300 x 600mm)	12" x 28" (305 x 712mm)	12" x 36" (305 x 915mm)	16" x 32" (406 x 813mm)	16" x 40" (406 x 1020mm)	20" x 40" (506 x 1020mm)
Max. grinding length (longitudinal)	18.9" (480mm)	20.47" (520mm)	23.62" (600mm)	28" (712mm)	36" (915mm)	32" (813mm)	40" (1020mm)	40" (1020mm)
Max. grinding width (crosswise)	8.9" (228mm)	11" (280mm)	11.81" (300mm)	13" (330mm)	13" (330mm)	16" (410mm)	16" (410mm)	20" (500mm)
Max. distance from table surface to spindle centerline: standard optional	18" (460mm) -	19.68" (500mm) 23.62" (600mm)	23" (585mm) -	24.8" (630mm) 28.35" (720mm)	24.8" (630mm) 28.35" (720mm)	24.8" (630mm) 28.35" (720mm)	24.8" (630mm) 28.35" (720mm)	24.8" (630mm) 28.35" (720mm)
Standard magnetic chuck size	8" x 18" (200 x 450mm)	10" x 20" (250 x 500mm)	11.81" x 23.63" (300 x 600mm)	11.81" x 27.56" (300 x 700mm)	11.81" x 35.43" (300 x 900mm)	15.75" x 31.5" (400 x 800mm)	15.75" x 39.37" (400 x 1000mm)	19.68" x 39.37" (500 x 1000mm)
Longitudinal movement of table								
Max. travel (hydraulic)	18.9" (480mm)	22.83" (580mm)	25.59" (650mm)	30" (760mm)	37.8" (960mm)	35" (890mm)	41.73" (1060mm)	41.73" (1060mm)
Max. travel (manual)	20" (510mm)	24.41" (620mm)	28.74" (730mm)	32.68" (830mm)	39.37" (1000mm)	36.61" (930mm)	43.31" (1100mm)	43.31" (1100mm)
Table speed infinitely variable	.196"-.984"/min. (5-25m/min.)	.196"-.984"/min. (5-25m/min.)	.196"-.984"/min. (5-25m/min.)	.196"-.984"/min. (5-25m/min.)	.196"-.984"/min. (5-25m/min.)	.196"-.984"/min. (5-25m/min.)	.196"-.984"/min. (5-25m/min.)	.196"-.984"/min. (5-25m/min.)
Crossfeed transverse travel								
Auto transverse increment	.04" - .4" (1-10mm)	.04" - .5" (1-13mm)	.04" - .75" (1-19mm)	.04" - 1" (1-25mm)	.04" - 1" (1-25mm)	.04" - 1" (1-25mm)	.04" - 1" (1-25mm)	.04" - 1" (1-25mm)
Auto constant feeding speed	.79" - 12.6" (20-320mm)/min.	.79" - 12.6" (20-320mm)/min.	.79" - 12.6" (20-320mm)/min.	.79" - 12.6" (20-320mm)/min.	.79" - 12.6" (20-320mm)/min.	.79" - 12.6" (20-320mm)/min.	.79" - 12.6" (20-320mm)/min.	.79" - 12.6" (20-320mm)/min.
Max. auto transverse travel	9.25" (235mm)	10.63" (270mm)	12.2" (310mm)	13.78" (350mm)	13.78" (350mm)	17" (430mm)	17" (430mm)	20" (510mm)
Max. manual transverse travel	9.84" (250mm)	11.81" (300mm)	13.39" (340mm)	15" (380mm)	15" (380mm)	18" (460mm)	18" (460mm)	20.47" (520mm)
Handwheel per revolution	0.2" (5mm)	0.2" (5mm)	0.2" (5mm)	0.2" (5mm)	0.2" (5mm)	0.2" (5mm)	0.2" (5mm)	0.2" (5mm)
Handwheel per graduation	.0005" (.0127mm)	.0005" (.0127mm)	.0005" (.0127mm)	.0005" (.0127mm)	.0005" (.0127mm)	.0005" (.0127mm)	.0005" (.0127mm)	.0005" (.0127mm)
Wheelhead vertical downfeed								
Automatic infeed	.00005"-.0025" (0.001 - 0.05mm)	.00005"-.0025" (0.001 - 0.05mm)	.00005"-.0025" (0.001 - 0.05mm)	.00005"-.0025" (0.001 - 0.05mm)	.00005"-.0025" (0.001 - 0.05mm)	.00005"-.0025" (0.001 - 0.05mm)	.00005"-.0025" (0.001 - 0.05mm)	.00005"-.0025" (0.001 - 0.05mm)
Step feed (JOG)	.00004" (0.001mm)	.00004" (0.001mm)	.00004" (0.001mm)	.00004" (0.001mm)	.00004" (0.001mm)	.00004" (0.001mm)	.00004" (0.001mm)	.00004" (0.001mm)
Rapid travel approx.	6" (150mm)/min	6" (150mm)/min	6" (150mm)/min	6" (150mm)/min	6" (150mm)/min	6" (150mm)/min	6" (150mm)/min	6" (150mm)/min
Slow travel, approx.	.236" (6mm)/min	.236" (6mm)/min	.236" (6mm)/min	.236" (6mm)/min	.236" (6mm)/min	.236" (6mm)/min	.236" (6mm)/min	.236" (6mm)/min
*Minimum display value	.00005" (.0127mm)	.00005" (.0127mm)	.00005" (.0127mm)	.00005" (.0127mm)	.00005" (.0127mm)	.00005" (.0127mm)	.00005" (.0127mm)	.00005" (.0127mm)
Grinding spindle drive								
Speed (rpm)	3450	3450	1750	1750	1750	1750	1750	1750
Power rating	2 Hp (1.5kw)	3 Hp (2.2kw)	5 Hp (3.7kw)	7.5 Hp (5.5kw)	7.5 Hp (5.5kw)	7.5 Hp (5.5kw)	7.5 Hp (5.5kw)	7.5 Hp (5.5kw)
Standard grinding wheel								
Diameter	8" (203mm)	8" (203mm)	12" (305mm)	14" (355mm)	14" (355mm)	14" (355mm)	14" (355mm)	14" (355mm)
Width	.5"-.75" (12.7-19mm)	.75"-.1" (19-25mm)	1.25" (31.75mm)	2" (50mm)	2" (50mm)	2" (50mm)	2" (50mm)	2" (50mm)
Bore	1.25" (31.75mm)	1.25" (31.75mm)	3" (76.2mm)	5" (127mm)	5" (127mm)	5" (127mm)	5" (127mm)	5" (127mm)
Hydraulic motor (power rating)	1 Hp (.75kw)	2 Hp (1.5kw)	2 Hp (1.5kw)	3 Hp (2.2kw)	3 Hp (2.2kw)	3 Hp (2.2kw)	3 Hp (2.2kw)	3 Hp (2.2kw)
Crossfeed motor (power rating)	1/2 HP 400W	1 HP 750W	1 HP 750W	1 HP 750W	1 HP 750W	1 HP 750W	1 HP 750W	1 HP 750W
Elevating motor (power rating)	60W x 4P	1/4 Hp (.2kw)	1/4 Hp (.2kw)	1/4 Hp (.2kw)	1/4 Hp (.2kw)	1/4 Hp (.2kw)	1/4 Hp (.2kw)	1/4 Hp (.2kw)
Total space required (LxWxH)	71.3" x 44.6" x 65.4" (1810x1285x1680mm)	93.7"x57"x68.9" (2380x1450x1750mm)	106.3"x63"x73" (2700x1600x1850mm)	116"x78"x81" (2950x1970x2050mm)	140"x78"x81" (3550x1970x2050mm)	130"x87"x81" (3290x2200x2050mm)	158"x87"x81" (4020x2200x2050mm)	164"x86.6"x82.7" (4170x2200x2100mm)
Weight								
Net weight	2,657 lbs (1205kg)	3,990 lbs (1810kg)	4,387 lbs (1990kg)	6,659 lbs (3020kg)	7,341 lbs (3330kg)	7,496 lbs (3400kg)	8,818 lbs (4000kg)	10,582 lbs (4800kg)
Gross weight (lbs)	3,031 lbs (1375kg)	4,762 lbs (2160kg)	5,038 lbs (2290kg)	7,760 lbs (3520kg)	8,157 lbs (3700kg)	8,818 lbs (4000kg)	9,920 lbs (4500kg)	11,464 lbs (5200kg)
Rated power, approx.	3.8 Hp (2.9kw)	7 Hp (5.2kw)	8.25 Hp (6kw)	12 Hp (8.9kw)	12 Hp (8.9kw)	12 Hp (8.9kw)	12 Hp (8.9kw)	12 Hp (8.9kw)
Packing dimensions	74"x72"x72" (1880x1830x1960mm)	98"x82"x83" (2480x2080x2100mm)	98"x84"x83" (2480x2140x2100mm)	98"x90"x87" (2500x2290x2220mm)	119"x91"x88" (3000x2290x2220mm)	111"x91"x88" (2800x2290x2220mm)	128"x90"x87" (3250x2290x2220mm)	138"x90"x87" (3500x2290x2220mm)

*ADSIII models have no elevating handwheel but jog buttons per revolution or graduations. Machine design, control, and specifications are subject to change without notice.

Clousing Large Capacity Precision ASDIII Automatic Surface Grinders



Shown with optional MPG, Dynamic Balancer, Coolant System with Auto Paper Feeding Device and Magnetic Separator



ASDIII Series Operation Panel

Delta PLC Digital Control features a 7.2" color touch screen and is equipped with the exclusive EQUIPTOP picture mode working system, easy to learn and operate.



Grinder Condition Input



Alarm Message



System Data



Starting Picture

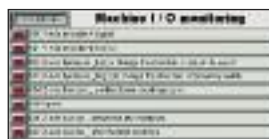

Machine I / O Monitoring

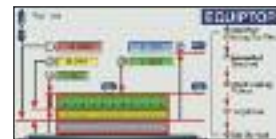

Grinding Size Input

Large Capacity Precision Automatic Surface Grinders Features...

- Large capacity up to 32" x 120" (810 x 3050mm) Table
- Enlarged extra strong ribbed column, ideal for heavy-duty grinding
- Table, saddle and base are constructed of high grade cast iron and ribbed for maximum strength
- Spindle is supported by 4 front and 2 rear precision angular contact ball bearings
- All slideways and ballscrews fully oiled by an automatic continuous lubrication system to minimize wear on slideways and ballscrews
- Longitudinal hydraulic transverse with constant speed function or manual speed handle. Table rides on double V slideways coated with "TURCITE-B" for maximum stability
- Cross traverse travel powered by DC servo motor and ballscrew, allows step feed and continuous infeed grinding.
- Vertical positioning by precision ballscrew
- Pre-set hydraulic table speed control allows operator to pre-set table speed rate and maintain the same speed rate every time the hydraulic table is engaged

Specifications: (CSG24 Series are Column type construction / CSG32 Series are Cantilever type construction)

Model	CSG2448ASDIII	CSG2460ASDIII	CSG2480ASDIII	CSG3260ASDIII	CSG3280ASDIII	CSG32120ASDIII
Table Size	23.6" x 47.24" (600 x 1200mm)	23.6" x 59" (600 x 1500mm)	23.6" x 78.7" (600 x 2000mm)	31.9" x 60" (810 x 1525mm)	31.8" x 80.7" (810 x 2050mm)	31.8" x 120" (810 x 3050mm)
Max. grinding length (longitudinal)	49.6" (1260mm)	61.4" (1560mm)	81" (2060mm)	61" (1550mm)	80.7" (2050mm)	120" (3050mm)
Max. grinding width (crosswise)	24" (610mm)	24" (610mm)	24" (610mm)	31.9" (810mm)	31.9" (810mm)	31.9" (810mm)
Max. distance from table surface to spindle centerline Standard	28.3" (720mm)	28.3" (720mm)	28.5" (720mm)	28.3" (720mm)	28.3" (720mm)	28.3" (720mm)
Optional	33.5" (850mm)	33.5" (850mm)	33.5" (850mm)	33.5" (850mm)	33.5" (850mm)	33.5" (850mm)
Standard magnetic chuck size	23.6" x 47.2" (600 x 1200mm)	23.6" x 29.5" ea 2pcs (600 x 750mm) ea 2pcs	23.6" x 39.37" ea 2pcs (600 x 1000mm) ea 2pcs	31.5" x 29.5" ea 2pcs (800 x 750mm) ea 2pcs	31.5" x 39.4" ea 2pcs (800 x 1000mm) ea 2pcs	31.5" x 39.4" ea 3pcs (800 x 1000mm) ea 3pcs
Longitudinal movement of table						
Max. travel (hydraulic)	51.18" (1300mm)	63" (1600mm)	82.7" (2100mm)	63" (1600mm)	82.5" (2100mm)	122" (3100mm)
Max. travel (manual)	53" (1350mm)	64.9" (1650mm)	84.6" (2150mm)	64.9" (1650mm)	84" (2150mm)	124" (3150mm)
Table speed infinitely variable	196"-984"/min. (5-25m/min)	196"-984"/min. (5-25m/min)	196"-984"/min. (5-25m/min)	196"-984"/min. (5-25m/min)	196"-984"/min. (5-25m/min)	196"-984"/min. (5-25m/min)
Column crossfeed transverse travel						
Auto transverse increment (jog)	0.04"-1" (1-25mm)	0.04"-1" (1-25mm)	0.04"-1" (1-25mm)	0.04"-1" (1-25mm)	0.04"-1" (1-25mm)	0.04"-1" (1-25mm)
Auto constant feeding speed	1"-11"/min. (25-280 mm/min)	1"-11"/min. (25-280 mm/min)	1"-11"/min. (25-280 mm/min)	1"-11"/min. (25-280 mm/min)	1"-11"/min. (25-280 mm/min)	1"-11"/min. (25-280 mm/min)
Max. auto transverse travel	26" (660mm)	26" (660mm)	26" (660mm)	33.8" (860mm)	33.8" (860mm)	33.8" (860mm)
Max. manual transverse travel	27" (690mm)	27" (690mm)	27" (690mm)	34.8" (885mm)	34.8" (885mm)	34.8" (885mm)
Handwheel per revolution	0.004" (.1mm)	0.004" (.1mm)	0.004" (.1mm)	0.004" (.1mm)	0.004" (.1mm)	0.004" (.1mm)
Handwheel per graduation	.00004" (.001mm)	.00004" (.001mm)	.00004" (.001mm)	.00004" (.001mm)	.00004" (.001mm)	.00004" (.001mm)
Wheelhead vertical infeed						
Automatic infeed	0.05" (1mm) jogging downfeed 0.25/10000" (0.001mm)					
Step feed (jog)	jogging downfeed: 1-25/10000" (0.001-0.05mm)					
Manual pulse generator (per graduation)	0.00005" (0.001mm)	0.00005" (0.001mm)	0.00005" (0.001mm)	0.00005" (0.001mm)	0.00005" (0.001mm)	0.00005" (0.001mm)
Rapid travel, approx.	18"(460mm)/min.	18"(460mm)/min.	18"(460mm)/min.	18"(460mm)/min.	18"(460mm)/min.	18"(460mm)/min.
Slow travel, approx.	0.25"(6mm)/min.	0.25"(6mm)/min.	0.25"(6mm)/min.	0.25"(6mm)/min.	0.25"(6mm)/min.	0.25"(6mm)/min.
Handwheel per revolution	0.004" (0.1mm)	0.004" (0.1mm)	0.004" (0.1mm)	0.004" (0.1mm)	0.004" (0.1mm)	0.004" (0.1mm)
Handwheel per graduation	0.00004" (0.001mm)	0.00004" (0.001mm)	0.00004" (0.001mm)	0.00004" (0.001mm)	0.00004" (0.001mm)	0.00004" (0.001mm)
Grinding spindle drive						
Speed (rpm)	1750	1750	1750	1750	1750	1750
Power rating	10 Hp (7.5kw)	10 Hp (7.5kw)	10 Hp (7.5kw)	15 Hp (10kw)	15 Hp (10kw)	15 Hp (10kw)
Standard grinding wheel						
Diameter	16" (405mm)	16" (405mm)	16" (405mm)	16" (405mm)	16" (405mm)	16" (405mm)
Width	2" (50mm)	2" (50mm)	2" (50mm)	2" (50mm)	2" (50mm)	3" (50mm)
Bore	5" (127mm)	5" (127mm)	5" (127mm)	5" (127mm)	5" (127mm)	5" (127mm)
Hydraulic motor (power rating)	7.5 Hp/6P	7.5 Hp/6P	7.5 Hp/6P	10 Hp/6P	10 Hp/6P	10 Hp/6P
Crossfeed motor (power rating)	2.6 Hp (2kw)	2.6 Hp (2kw)	2.6 Hp (2kw)	2.6 Hp (2kw)	2.6 Hp (2kw)	2.6 Hp (2kw)
Elevating motor (power rating)	2.6 Hp (2kw)	2.6 Hp (2kw)	2.6 Hp (2kw)	2.6 Hp (2kw)	2.6 Hp (2kw)	2.6 Hp (2kw)
Total space required (LxWxH)	170"x138"x 93" (4300x3500x2350mm)	193"x138"x 93" (4902x3500x2350mm)	233"x138"x 93" (5900x3500x2350mm)	244"x146"x 109" (6200x3700x2750mm)	284"x146"x 97" (7200x3700x2450mm)	367"x146"x 97" (9300x3700x2450mm)
Net weight (lbs)	14,330 (6500kg)	16,535 (7500kg)	18,740 (8500kg)	29,700 (13500kg)	33,000 (15000kg)	37,400 (17000kg)
Gross weight (lbs)	16,535 (7500kg)	18,740 (8500kg)	20,944 (9500kg)	33,000 (15500kg)	36,300 (16500kg)	41,800 (19000kg)

Clausing Grinder Optional Accessories

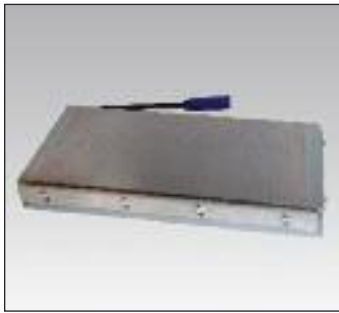

Permanent Magnetic Chuck



Electro Magnetic Chuck



Inclinable Permanent Magnetic Chuck



Chuck Control with Demagnetizer



Coolant System



Coolant System with Magnetic Separator



Dust Collector



Coolant and Dust Unit



Coolant System with Manual Paper Feeding



Auto Paper Feeding Device with Magnetic Separator

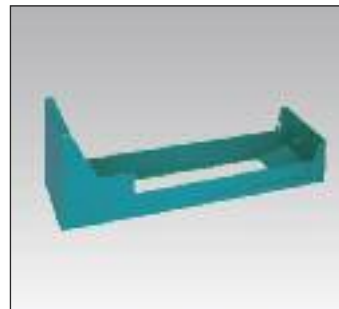

Extra Splash Guard

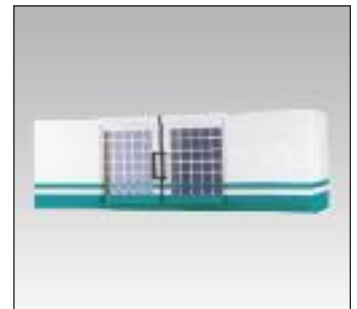

Full Guarding Splash Guard (10/12/16 Series)



Manual Parallel Dressing Attachment



Electric Parallel Dressing Attachment



Adjustable Speed Rotary Magnetic Chuck

Clausing Grinder Standard Accessories

- Diamond Dresser
- Auto Lubrication System
- Wheel Flange
- Chuck control on all models except on 618 & 818 manual and 2A/3A hydraulic models
- Grinding Wheel
- Balancing Arbor
- Wheel Extracting Screw & Nut
- Leveling Screws with Blocks
- Touch-up Paint
- Tool Box and Tools



Dynamic Balancer



Punch Former



Digital Readout



Spare Wheel Flange



Halogen Work Light

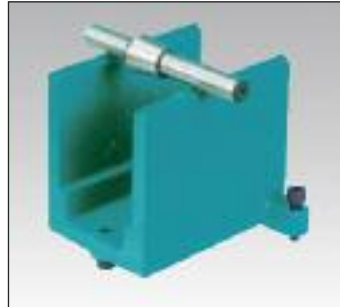

*Balancing Stand
(Double Line)*



Roller Type Balancing Stand



*Micro Crossfeed for
616/818 Series*



*Micro Crossfeed for
10/12/16 Series*



*Micro Down Feed for
10/12/16 Series (STD on 2A
& 3A1020-2040 models)*



*Manual Pulse Generator
Standard ASDIII Series
(stationary in counsel STD)*



Precision Vice 3" or 4"



Frequency Changer

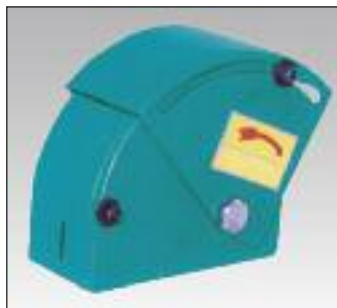

Swivel Wheel Guard



*Concave/Convex Forming
Dresser*



Your Single Source for Machine Tools

Clausing Precision Drills

- Clausing Belt-drive Drills
- Clausing Geared-head Drills
- Clausing Radial Drills

Clausing Precision Mills

- Clausing Bed Mills
- Clausing CNC Bed Mills
- Clausing Knee Mills
- Clausing EVS Knee Mills
- Clausing Universal Mills

Clausing Precision Lathes

- Clausing/Colchester Geared Head Lathes
- Clausing/Colchester Professional V.S. Lathes
- Clausing/Colchester MAGNUM V.S. Lathes
- Clausing MA/MAV Series Lathes
- Clausing Large Swing Standard vLathes
- Clausing Large Swing CNC Lathes

Clausing Precision Grinders

- Clausing Manual Grinders
- Clausing 2 Axes Hydraulic Grinders
- Clausing 3 Axes Hydraulic Grinders
- Clausing ASDIII Automatic Grinders

Clausing Precision Cutting Machines

- Clausing/Kalamazoo Horizontal Bandsaws
- Clausing/Kalamazoo Vertical Bandsaws
- Clausing/Kalamazoo Tilt Frame Miter Bandsaws
- Clausing/Kalamazoo Cold Saws

For detailed catalogs of the full line of Clausing Machine Tools visit our Web Site:

www.clausing-industrial.com

Fax: 269-345-5945 or e-mail us and request an electronic (pdf) catalog at:

info@clausing-industrial.com

Your Authorized Clausing Precision Machine Tools Distributor



Call 800-323-0972 for the Clausing Dealer Nearest You
or visit www.clausing-industrial.com

Celebrating Over A Century in the Machine Tool Business