



CYLINDER GRINDERS

A Line of Precision Low-cost,
High Performance Cylinder Grinders

Clausing Industrial high precision cylinder grinders are unmatched in structural rigidity and stability, grinding accuracy and operational and operational convenience. Each machine provides maximum operational flexibility thereby allowing for various grinding operations. You will get extra value when putting Clausing cylinder grinders on your production line.

Stable and Rigid Spindle Head

- The spindle runs on precision bearings, assuring maximum spindle stability. It guarantees outstanding accuracy for external and internal diameter grinding and face grinding.
- The spindle head swivels +90 deg -30 deg.
- The spindle head on the 8" series machines provides variable speed changed by frequency inverter.
- The spindle head on the 12" and 16" series is driven by servo motor, providing variable speed.

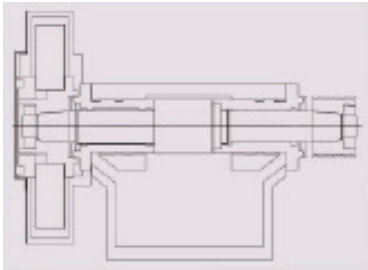

Precision Wheel Head

The grinding wheel spindle is precision machined from high quality alloy steel SNCM-220, normalized, tempered, carburized and sub-zero treated, precision ground and mirror-effect treated. Hardness reaches to over HRC62 deg. No deformation, maximum wear resistance and lifetime accuracy can be assured.

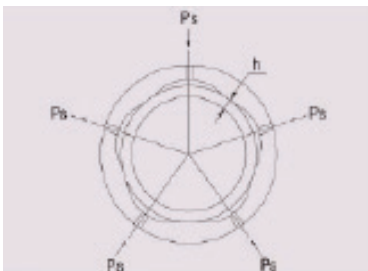

Special Hydrostatic Bearing

The wheel spindle runs by using a special hydrostatic bearing and is especially ideal for precision grinding work. It features high speed no friction between metals, no heat generation deformation-free, extra high accuracy and continual use.

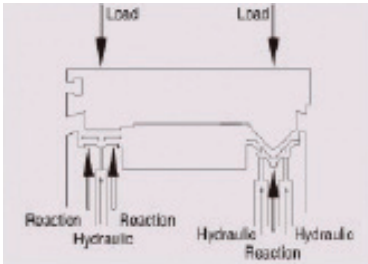

Advanced Hydrostatic Lubrication System

The slideways of the table and the wheel head are lubricated by an advanced automatic hydrostatic lubrication system. This provides various features, such as extremely smooth movement, added accuracy and superior grinding accuracy.

OUTSTANDING FEATURES AND CONSTRUCTION

Wheel Forming Device *(manual type, without auto compensation) (optional)*

The device is located above the wheel and driven by a hydraulic unit to slide in longitudinal direction. It is equipped with a diamond tool for dressing and a forming board for profiling. These operations are accomplished without moving the working table. The device is compatible with all series of cylinder grinders.

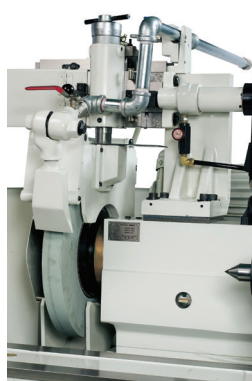

Wheel forming device *(for NC models with auto compensation) (optional)*

The device functions as the manual wheel forming device. It further employs an automatic hydraulic unit, and compensation parameters are able to be set during operation (driven by motor) for fast grinding compensation. The device can be equipped on NC models.

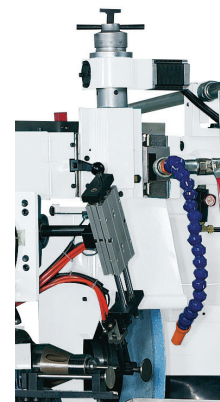

GRINDING EXAMPLES

A grinder allows for various grinding applications with changeover ease.



Straight Plunge Grinding

- For small lot production, use automatic feed combined with sparkout timer to achieve superior grinding quality. For mass production, use 2-step automatic feed and 2-step automatic measurement device (optional for upgrading productivity and grinding quality).



Shoulder Grinding

- Provides workpiece outside diameter and shoulder grinding accomplished at a time.
- Easy to set up. Simply clamp the workpiece between two centers, mount the grinding wheel on the right side of the wheel head and swivel the head to a degree for performing grinding.



Traverse Grinding

- Use automatically intermittent feed combined with hydraulic drive of table for the most effective traverse grinding operations.



End Surface Grinding

- Dismantle the spindle head cover. Mount a 3-jaw or 4-jaw chuck. Change position of the pin for chuck rotation. Position the pin at a 90 degree angle for end surface grinding.



Taper Grinding

- Hold the workpiece by a chuck or two centers. The table and the wheel head can be easily adjusted and swiveled.



Internal Grinding

- To proceed with internal grinding with a hinge-type internal grinding attachment (optional accessory), simply pull down the internal grinding spindle and fix it in place.

PRECISION CYLINDER GRINDERS

CCG816S



CCG816SNC



Features

- Distance between centers 15.7" (400mm)
- Swing over table 7.8" (200mm)
- Maximum grinding diameter 7" (180mm)
- Variable speed 10–300 rpm
- Frequency inverter control
- Semi-auto feed
- Hydraulically operated traverse moving
- Wheel head provides rapid feed and manual feed for grinding

Features

- Distance between centers 15.1" (400mm)
- Swing over table 7.8" (200mm)
- Maximum grinding diameter 7 (180mm)
- NC computer controlled combined with conversational operation control for maximum operator convenience
- Variable spindle speed 10–300 rpm
- Automatic feed is driven by servomotor
- Hydraulically operated traverse feed

MODEL	CCG816S	CCG816SNC	MODEL	CCG816S	CCG816SNC
CAPACITY			TABLE		
Distance Between Centers	15.7" (400mm)		Swivel Angle	from -3°, to +12°	
Swing Over Table	7.87" (200mm)		Traverse Speed	1.96 – 212.5 in/min (50 – 5400mm/min)	
Maximum Load of Centers	132 lbs. (60kgs)		Auto. Reciprocate Min. Stroke	0.3149" (8mm)	
Maximum External Grinding Diameter	7" (180mm)		Feed of One Turn of Handwheel (2-step)	0.787" (0.0787") (20mm (2mm))	
WHEEL HEAD			MOTOR		
Swivel Angle	± 30 °		Wheel Spindle	3 HP /4P (2.2 kw (4P))	
Manual Distance	5.3" (135mm)		Workhead Spindle	1/2 Hp /4P (0.37 kw (4P))	
Auto Rapid Advance	0.98" (25mm)		Hydraulic Pump	1/2 Hp /4P (0.37 kw (4P))	
Sliding Seat Supplementary Displacement	95 (total 10 (255mm))		Wheel Spindle Lurication Pump	1/4 Hp /4P (0.18 kw (4P))	
Minimum Setting Unit	0.000039" (0.001mm)		Coolant Pump	1/4 Hp /2P (0.18 kw (2P))	
One Turn of Handwheel (graduation)	2 (0.000196" (0.005mm))		Internal Grinding Spindle (optional)	1/4 Hp /2P (0.18 kw (2P))	
GRINDING WHEEL			TANK CAPACITY		
O.D. x Width x I.D.	13.97" x 1.49" x 5" (355 x38 x 127mm)		Wheel Spindle Lubrication Tank	7 L	
Speeds (belt-type) rpm	2085 / 2495		Hydraulic Fluid Tank	63 L	48 L
WORK SPINDLE HEAD			Coolant Tank	110 L	
Swivel Angle	120° (+90°, -30°)		MACHINE SIZE		
Center Taper	MT3		Net Weight	4,400 lbs. (2000 kgs)	
Spindle Speeds (variable) rpm	10 – 300		Shipping Weight	5,000 lbs. (2275 kgs)	
Maximum Load of Spindle (tool holder included)	33 lbs. (15kgs) Max Length: 3.93" (100mm)		Floor Dimensions Width x Depth x Work Height	91.2" x 79.5" x 41.8" (2315 x 2019 x 1060mm)	
TAILSTOCK			Shipping Dimensions	100" x 89" x 50" (2540 x 2260 x 1270mm)	
Center Taper	MT3				
Stroke	0.787" (20mm)				

All specifications subject to change without notice or obligation.

CCG913AL, CCG919AL, CCG929AL



Features

- Distance between centers 15.1" (400mm)
 - 13.7" (350mm)
 - 19.6" (500mm)
 - 29.5" (750mm)
- Swing over table 9.8" (250mm)
- Maximum grinding diameter 9.8 (250mm)
- Variable spindle 2 speed to 1900 rpm

Standard Accessories

- Wheel flange with nut
- Table mounted wheel dresser
- 2 Carbide tipped centers
- Work Driving Dog Set (3 pcs)
- Tool Box
- Coolant System
- Fagor DRO for Imperial Measurement

AL-Series:

X-axis is manual feed and z-axis is driven by worm gear with rack gear. The work head positioning brake unit is the standard accessory. It can notably save loading and unloading time. Operator friendly controls allow for quick machine operation skills

Machine Bed was designed using the most advanced mechanical principles, to minimize the external factors the can adversely impact accuracy. The bed is virtually vibration free. Constructed of high quality Meehanite cast iron, fully normalized for stability and distortion-free operation. The machine bed and slides are heat treated and precision ground with longer span guideways for optimum work table support.



Longitudinal and Cross Slides are configured with a V and Flat Way. They are hand scraped and equipped with automatic lubrication system which presets the pressure and operation for smoothness and accuracy.

MODEL	CCG913AL	CCG919AL	CCG929AL	MODEL	CCG913AL	CCG919AL	CCG929AL
CAPACITY				TABLE			
Distance Between Centers	13.78" (350mm)	19.68" (500mm)	29.5" (750mm)	Swivel Angle	from -4°, to +8°		
Swing Over Table	9.84" (250mm)			MOTOR			
Maximum Load of Centers	176 lbs. (80 kgs)			Wheel Spindle	5 HP /4P (3.7 kw (4P))		
Maximum External Grinding Diameter	9.84" (250mm)			Workhead Spindle	1/2 Hp /4P (0.37 kw (4P))		
WHEEL HEAD				Z-Axis Motor	1/2 Hp /4P (0.37 kw (4P))		
Swivel Angle	± 30 °			Wheel Spindle Lurication Pump	1/8 Hp /4P (0.10 kw (4P))		
Manual Distance	5.9" (150mm)			Coolant Pump	1/8 Hp /2P (0.10 kw (2P))		
Auto Rapid Advance	0.98" (25mm)			Table Lubricator Motor	1/8 Hp /2P (0.10 kw (2P))		
FEED SLIDE				TANK CAPACITY			
X-Axis minimum resolution increment	0 – 0.000984" (0 – 0.0025)			Wheel Spindle Lubrication Tank	7 L		
Z-Axis rapid feed rate	0 – 157 in/min (0 – 4 m/min)			Hydraulic Fluid Tank	NA		
GRINDING WHEEL				Coolant Tank	110 L		
O.D. x Width x I.D.	13.97" x 1.49" x 4" (355 x38 x 101.6mm)			MACHINE SIZE			
Speeds (2 speed variable change) rpm	1900 /1500			Net Weight	4,900 lbs. (2250 kgs)	5,390 lbs. (2450 kgs)	6,050 lbs (2750 kgs)
WORK SPINDLE HEAD				Shipping Weight	5,500 lbs. (2500 kgs)	5,940 lbs. (2700 kgs)	6,600 lbs. (3000kgs)
Swivel Angle	90°			Floor Dimensions	Width x Depth x Work Height		
Center Taper	MT4				59" x 36.5" x 53" (1500) x 927 x 1343mm)		
Spindle Speeds (variable) rpm	0 – 300			Shipping Dimensions	79" x 53" x 61" (2000 x 1300 x 1550 mm)		
Maximum Load of Spindle (tool holder included)	33 lbs. (15kgs) Max Length: 3.93" (100mm)						
TAILSTOCK							
Center Taper	MT3						
Stroke	0.984" (25mm)						

All specifications subject to change without notice or obligation.

PRECISION CYLINDER GRINDERS

CCG1224S / CCG1624S



12" Features

- Swing over table 12.5" (320mm)
- Maximum grinding diameter 11.8" (300mm)

16" Features

- Swing over table 16.5" (420mm)
- Maximum grinding diameter 15.7" (400mm)

Common Features

- Distance between centers 23.6" (600mm)
- Variable spindle speed 10 300 rpm, drive by servo motor
- Semi auto feed
- Hydraulically operated traverse moving
- Wheel head provides rapid feed and manual feed from grinding

CCG1224SNC / CCG1624SNC



12" Features

- Swing over table 12.5" (320mm)
- Maximum grinding diameter 11.8" (300mm)

16" Features

- Swing over table 16.5" (420mm)
- Maximum grinding diameter 15.7" (400mm)

Common Features

- Distance between centers 23.6" (600mm)
- NC computer controlled combined with conversational operation control for maximum operational convenience
- Variable spindle speed 10–300 rpm, driven by servomotor
- Automatic feed is driven by servomotor
- Hydraulically operated traverse feed

MODEL	CCG1224S / CCG1624S	CCG1224SNC / CCG1624SNC	MODEL	CCG1224S / CCG1624S	CCG1224SNC / CCG1624SNC
CAPACITY	23.6" (600mm)		TABLE	from -2°, to +10°	
Distance Between Centers	23.6" (600mm)		Swivel Angle	from -2°, to +10°	
Swing Over Table	12.5" (320mm)	16.5" (420mm)	Traverse Speed	1.96 – 212.5 in/min (50 – 5400mm/min)	
Maximum Load of Centers	220 lbs. (100kgs)	330 lbs. (150kgs)	Auto. Reciprocate Min. Stroke	0.3149" (8mm)	
Maximum External Grinding Diameter	11.8" (300mm)	15.7" (400mm)	Feed of One Turn of Handwheel (2-step)	0.787" (0.0787") (20mm (2mm))	
WHEEL HEAD	± 30 °		MOTOR		
Swivel Angle	6.3" (160mm)		Wheel Spindle	5 HP /4P (3.7 kw (4P))	
Manual Distance	1.57" (40mm)		Workhead Spindle	1-1/8 Hp /4P (0.85 kw (4P))	
Auto Rapid Advance	95 (total 11.6" (295mm))		Hydraulic Pump	1/2 Hp /4P (0.37 kw (4P))	
Sliding Seat Supplementary Displacement	0.000039" (0.001mm)		Wheel Spindle Lurication Pump	1/4 Hp /4P (0.18 kw (4P))	
Minimum Setting Unit	2 (0.000196" (0.005mm))		Coolant Pump	1/4 Hp /2P (0.18 kw (2P))	
One Turn of Handwheel (graduation)			Internal Grinding Spindle (optional)	1 Hp /2P (0.75 kw (2P))	
GRINDING WHEEL			TANK CAPACITY		
O.D. x Width x I.D.	15.9" x 1.96" x 5" (405 x 50 x 127mm)		Wheel Spindle Lubrication Tank	9 L	
Speeds (belt-type) rpm	1783 /1940		Hydraulic Fluid Tank	46 L	46 L
WORK SPINDLE HEAD			Coolant Tank	110 L	
Swivel Angle	120° (+90° , -30°)		MACHINE SIZE		
Center Taper	MT4		Net Weight	5,720 lbs. (2600 kgs)	6,160 lbs. (2800 kgs)
Spindle Speeds (variable) rpm	10 – 300		Shipping Weight	6,420 lbs. (2918 kgs)	6,860 lbs. (3118 kgs)
Maximum Load of Spindle (tool holder included)	77 lbs. (35kgs) Max Length: 5.9" (150mm)		Floor Dimensions Width x Depth x Work Height	129" x 86" x 44"	129" x 86" x 44"
TAILSTOCK				3279 x 2185 x 1100mm	3279 x 2185 x 1100mm
Center Taper	MT4		Shipping Dimensions	139" x 96" x 54"	139" x 96" x 54"
Stroke	0.984" (25mm)			3530 x 2438 x 1370mm	3530 x 2438 x 1370mm

All specifications subject to change without notice or obligation.

**CCG1240S, CCG1640S / CCG1260S,
CCG1660S / CCG1280S, CCG1680S**



12" Features

- Swing over table 12.5" (320mm)
- Maximum grinding diameter 11.8" (300mm)

16" Features

- Swing over table 16.5" (420mm)
- Maximum grinding diameter 15.7" (400mm)

Common Features

- Distance between centers 39.3" (1000mm), 59" (1500mm), 78.7" (2000mm)
- Variable spindle speed 10–300 rpm driven by servomotor
- Semi-auto feed
- Hydraulically operated traverse moving
- Wheel head provides rapid feed and manual feed for grinding

**CCG1240SNC, CCG1640SNC / CCG1260SNC,
CCG1660SNC / CCG1280SNC, CCG1680SNC**



12" Features

- Swing over table 12.5" (320mm)
- Maximum grinding diameter 11.8" (300mm)

16" Features

- Swing over table 16.5" (420mm)
- Maximum grinding diameter 15.7" (400mm)

Common Features

- Distance between centers
- 39.3" (1000mm), 59" (1500mm), 78.7" (2000mm)
- NC computer controlled combined with conversational operation control for maximum operational convenience
- Variable spindle speed 10–300 rpm driven by servomotor
- Automatic feed is driven by servomotor
- Hydraulically operated traverse feed

MODEL	CCG1240S /SNC	CCG1260S /SNC	CCG1280S /SNC	CCG1640S /SNC	CCG1660S /SNC	CCG1680S /SNC	MODEL	CCG1240S /SNC	CCG1260S /SNC	CCG1280S /SNC	CCG1640S /SNC	CCG1660S /SNC	CCG1680S /SNC
CAPACITY							TABLE						
Distance Between Centers	39.3" (1000mm)	59" (1500mm)	78.7" (2000mm)	39.3" (1000mm)	59" (1500mm)	78.7" (2000mm)	Swivel Angle	-2°, to +10°	-3°, to +7°	-1°, to +7°	-2°, to +10°	-3°, to +7°	-1°, to +7°
Swing Over Table	12.5" (320mm)			16.5" (420mm)			Traverse Speed	1.96 - 212.5 in/min (50 – 5400mm/min)					
Maximum Load of Centers	220 lbs. (100kgs)			330 lbs. (150kgs)			Auto. Reciprocate Min. Stroke	0.3149" (8mm)					
Maximum External Grinding Diameter	11.8" (300mm)			15.7" (400mm)			Feed of One Turn of Handwheel (2-step)	0.787" (0.0787") (20mm (2mm))					
WHEEL HEAD							MOTOR						
Swivel Angle	± 30 °						Wheel Spindle	5 HP /4P (3.7 kw (4P))					
Manual Distance	6.3" (160mm)						Workhead Spindle	1-3/4 Hp / 2.5 Hp (1.3 kw /2.0 kw)					
Auto Rapid Advance	1.57" (40mm)						Hydraulic Pump	1/2 Hp /4P (0.37 kw (4P))					
Sliding Seat Supplementary Displacement	95 (total 11.6" (295mm))						Wheel Spindle Lubrication Pump	1/4 Hp /4P (0.18 kw (4P))					
Minimum Setting Unit	0.000039" (0.001mm)						Coolant Pump	1/4 Hp /2P (0.18 kw (2P))					
One Turn of Handwheel (graduation)	2 (0.000196" (0.005mm))						Internal Grinding Spindle (opt)	1 Hp /2P (0.75 kw (2P))					
GRINDING WHEEL							TANK CAPACITY						
O.D. x Width x I.D.	15.9" x 1.96" x 5" (405 x 50 x 127mm)						Wheel Spindle Lubrication Tank	9 L					
Speeds (belt-type) rpm	1783 /1940						Hydraulic Fluid Tank	63 L (S series) 46 L (NC Series)		63 L (S series) 46 L (NC Series)			
WORK SPINDLE HEAD							Coolant Tank	110 L					
Swivel Angle	120° (+90° , -30°)						MACHINE SIZE						
Center Taper	MT4						Net Weight	7,040lbs. (3200kgs)	9,020lbs. (4100kgs)	13,200lbs. (6000kgs)	7,480lbs. (4300kgs)	9,460lbs. (4300kgs)	13,640lbs. (6200kgs)
Spindle Speeds (variable) rpm	10 – 300						Shipping Weight						
Maximum Load of Spindle (tool holder inc)	77 lbs. (35kgs) Max Length: 5.9" (150mm)						Floor Dimensions:	184"x86"x44"	250"x87"x44"	323"x87"x44"	184"x86"x45"	250"x87"x45"	323"x87"x45"
TAILSTOCK							Width x Depth x Work Height (mm)	4676x2185x1100	6354x2200x1100	8199x2200x1100	4676x2185x1150	6354x2200x1150	8199x2200x1150
Center Taper	MT4						Shipping Dimensions	194"x96"x54"	260"x97"x54"	333"x97"x54"	194"x97"x54"	260"x97"x54"	333"x97"x54"
Stroke	0.984" (25mm)							4928x2438x1372	6600x2464x1372	8458x2464x1372	4928x2438x1372	6600x2464x1372	8458x2464x1372

All specifications subject to change without notice or obligation.

CNC CYLINDER GRINDERS

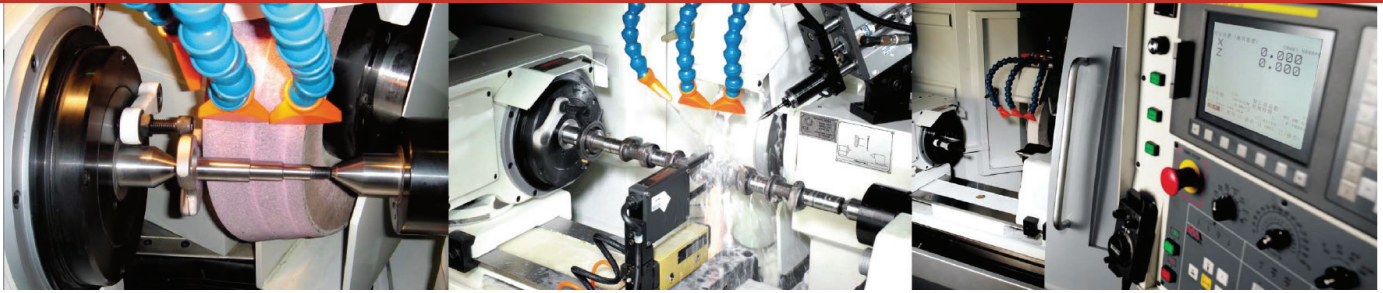

The Clausing series CNC cylinder grinders are designed with high efficiency, high accuracy and maximum operational convenience in mind. The machine design and structure meets ergonomic theories for user friendly operation. Rigid and stable construction, as well as a special wheel spindle design are combined with advanced CNC control to make cylinder grinding easier and more accurate than ever before.

CCG1216CNC Shown with Optional Full Guarding



Advanced concepts, state of the art techniques, and innovative design can be found on the Clausing Series CNC Cylinder Grinder giving it a competitive edge for today's precision grinding. Specially designed fine feed allows mirror-effect grinding and end face grinding achieving the accuracy of 0.1um. A wide range of optional equipment is available to meet customer's requirements, and effectively upgrades the machines overall performance.

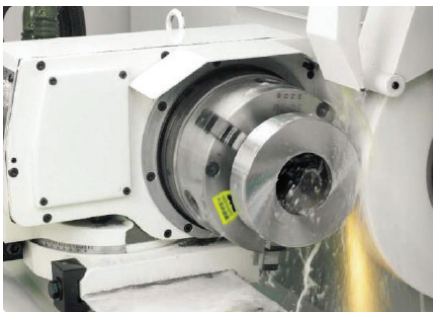

Plunge Cylinder Grinding

- Two Axis control combined with one auxiliary axis for workhead spindle running.
- Least input increment: 0.001mm.

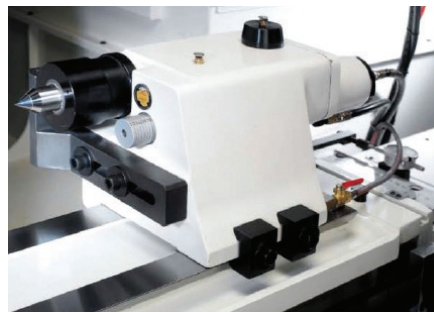

Hydraulic Tailstock Option

- The rigid tailstock is locked on the slide firmly. The tailstock quill movement is driven by hydraulic power for convenient and fast workpiece clamping and unclamping.



Touch Probe Option

- Provides fast measurement for reference point on end face.



Linear Scale for Z Axis Option

- The linear scale provides closed-loop control, assuring extremely high positioning accuracy.



Automatic Grinding Wheel Balancers Option

- Allows for fast accurate balancing.

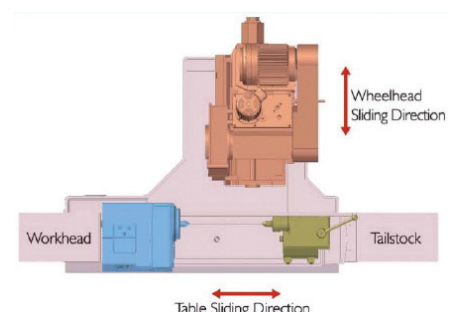

Easy to Check Table Position

- As the wheelhead advances/retracts in a straight line, even with the angular type, the wheel and workpiece longitudinal positions can be checked easily.

CNC GRINDING FEATURES

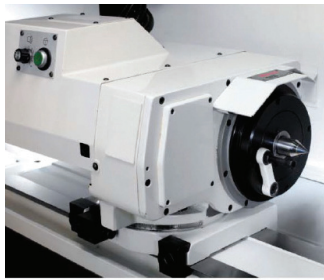

Rigid Spindle Head

- The rigid construction spindle head employs high precision bearings assuring maximum spindle stability
- The spindle head is driven by servomotor providing variable speed change.

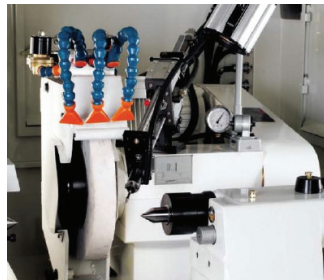

Precision Wheel Spindle

- The grinding wheel spindle is precisely machined from high quality alloy steel (SNCM-220) Normalized, Tempered, carburized, and sub-zero treated, precisely ground and mirror-effect treated. Harness reaches over HRC62.

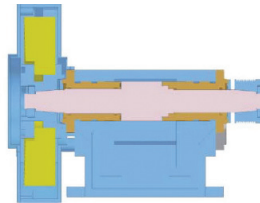

Wheel Spindle with Hydro-Static Bearing Absolutely No Metal-to-Metal Contact

- Hybrid hydro-static bearings are used for the wheel spindle bearings. Metal-to-Metal contact will never occur with these highly rigid bearings.

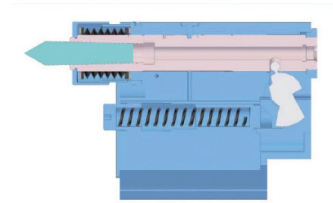

Tailstock Lubrication System

- An automatic oil bath lubrication system has been provided for the tailstock to maintain a high-level of accuracy. An oil level gauge enables quick and sure oil level checks.

GRINDING CYCLE PATTERNS

Straight Type

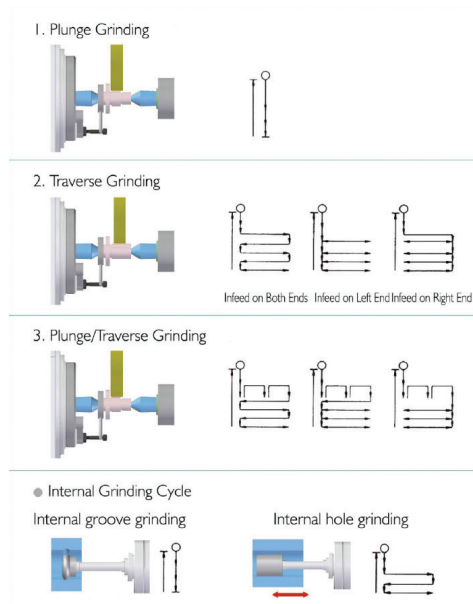

Angular Type

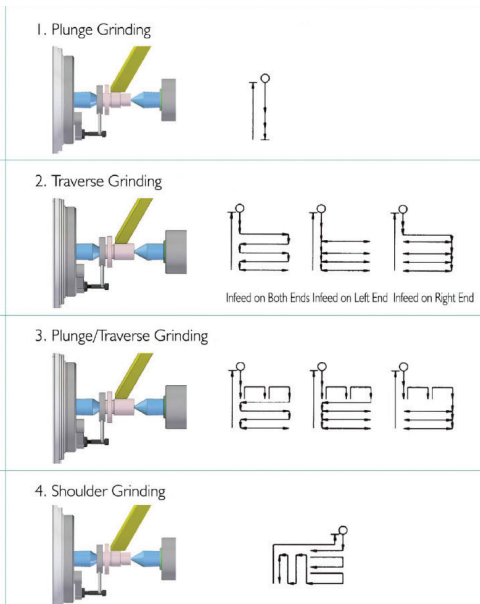

1. Self-developed function, cycle patterns grinding cycle, makes program editing easier.
2. The optional Crush Proof / Gap Control device shortens machine time and prevents bumping caused by program errors.
3. Optional Auto In-process Gauge is ideal for plunge and traverse grinding operations.
4. Multi-Step internal grinding can be conducted through program auto grinding control.

WHEEL DRESSING CYCLES

Straight Type

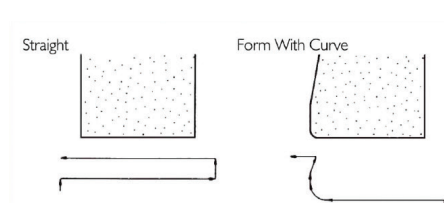

Angular Type

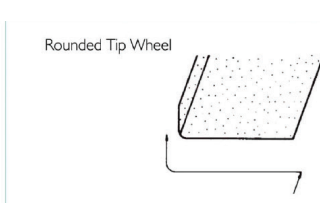

1. A Tri-direction, single point dresser is standard accessory.
2. A plate type roller dresser is available as an option.
3. A profile rolling dresser is available as an option.

FANUC OI CNC CONTROL FEATURES WITH 9" CRT/MDI HIGH RESOLUTION SCREEN



Features

- Program Storage 160M
- Registered Program
- Program Number Search
- Program Protection
- Background Editing
- Bilingual Display, English/Chinese
- Display of Spindle Speed, T-Code
- Workpiece Quantity and Processing
- Time of Screen
- Actual Speed Display
- External Key Input
- External Message
- I/O Device Control
- MDI Operation
- Program Reset
- Dry Run
- Single Block
- Program Protection
- Emergency Stop
- Status Display
- Incremental Pulse Code Interface
- Automatic Coordinate Setting
- Workpiece Coordinate Setting
- Z-axis Simultaneous Controlability
- Least Input Increment
- Rapid Traverse Override
- Automatic Acceleration /Deceleration
- Linear Acceleration /Deceleration After Cutting
- Feed Interpolation
- Feedrate Override 0 to 150%
- Linear Interpolation
- Circular Interpolation
- Reference Position Return
- Reference Position Return Check
- Program Combine
- Special G-Code Input
- Programming Input of Offset Data
- Custom Macro B
- Inch / Metric Conversion
- Tool Nose Radius Compensation
- Canned Cycles for Grinding
- X-Axis Diameter / Radius Command
- 32 pairs of Offsets
- *many more functions*

CCG79CNC



CCG715CNC



Features

- Full CNC Control Fanuc Oi
- Optional Fully enclosed Splash Guard Shown (optional)
- Swing over table 7.8" (200mm)
- Distance between centers 9.8" (250mm)
- General Purpose Grinding Wheel
- Linear scale for X-axis
- Diamond tool dresser table mount type
- Coolant System
- Hydraulic System
- Carbide tipped work centers
- Worklight
- Tool box and tools

Features

- Full CNC Fanuc Oi Control
- Optional Fully enclosed Splash Guard Shown (optional)
- Swing over table 7.8" (200mm)
- Distance between centers 15.7" (400mm)
- General Purpose Grinding Wheel
- Linear scale for X-axis
- Diamond tool dresser table mount type
- Coolant System
- Hydraulic System
- Carbide tipped work centers
- Worklight
- Tool box and tools

MODEL	CCG79CNC	CCG715CNC	MODEL	CCG79CNC	CCG715CNC
CAPACITY			TABLE		
Distance Between Centers	9.8" (250mm)	15.7" (400mm)	Swivel Angle	from -3°, to +10°	
Swing Over Table	7.87" (200mm)		Rapid feed Rate	236 in/min (6m/min)	
Maximum Load of Centers	132 lbs. (60kgs)		Minimum Input Increment	0.001mm (0.0001mm)	
Maximum External Grinding Diameter	7" (180mm)		MOTOR		
WHEEL HEAD			Wheel Spindle	3 HP /4P (2.3 kw (4P))	
Auto Rapid Advance	236 in/min (6m/min)		Workhead Spindle Frequency Inverter	1 Hp /4P (0.75 kw (4P))	
Min Input Increment	0.001mm (0.0001mm)		Wheel Head Feed AC Servo Motor	1 Hp (0.75 kw)	
Internal Grinding	Manual Elevation		Table Feed AC Servo Motor	1-1/2 Hp (1.2 kw)	
GRINDING WHEEL			Hydraulic Pump	1/2 Hp /4P (0.37 kw (4P))	
O.D. x Width x I.D.	13.97" x 1.49" x 5" (355 x38 x 127mm)		Wheel Spindle Lubrication Pump	1/2 Hp /4P (0.37 kw (4P))	
Speed rpm	2085		Coolant Pump	1/4 Hp / 2P (.18 kw (2P))	
Linear Velocity	30 m/s		Internal Grinding Spindle (optional)	1/4 Hp / 2P (.18 kw (2P))	
WORK SPINDLE HEAD			TANK CAPACITY		
Swivel Angle	120° (+90° , -30°)		Wheel Spindle Lubrication Tank	12 L	
Center Taper	MT3		Hydraulic Fluid Tank	60 L	
Spindle Speeds (variable) rpm	10 – 300		Coolant Tank	110 L	
Maximum Load of Spindle (tool holder included)	33 lbs. (15kgs) Max Length: 3.93" (100mm)		MACHINE SIZE		
TAILSTOCK			Net Weight	4,950 lbs. (22350 kgs)	5,170 lbs 2350 kgs)
Center Taper	MT3		Shipping Weight	5450 lbs. (2478 kgs)	5670 lbs. (2580 kgs)
Stroke	0.787" (20mm)		Floor Dimensions Width x Depth x Work Height	74.8" x 90" x 75.2" (1900x2290x1910mm)	97.6" x 105.5" x 74" (2480x2680x1880mm)
			Work Height	41.4" (1050 mm)	
			Shipping Dimensions	85" x 100" x 85" (2160x2540x 2160mm)	110" x 115" x 85" (2795x2925x 2160mm)

All specifications subject to change without notice or obligation.

CCG1216CNC, CCG1224CNC, CCG1240CNC, CCG1260CNC, CCG1280CNC



Shown with optional full splash guard

Features

- Full CNC Fanuc Oi control
- Semi Enclosed Splash Guard Standard, Full enclosed splash guard (optional)
- Swing over table 12.5" (320mm)
- Distance between centers 16" to 80" (40-2000mm)
- General Purpose Grinding Wheel
- Linear Scale for X-Axis
- Diamond Tool Dresser Table Mount Type
- Coolant System
- Hydraulic System
- Carbide tipped Work Centers
- Worklight
- Tool Box and Tools

MODEL	CCG1216CNC	CCG1224CNC	CCG1240CNC	CCG1260CNC	CCG1280CNC	MODEL	CCG1216CNC	CCG1224CNC	CCG1240CNC	CCG1260CNC	CCG1280CNC
CAPACITY						MOTOR					
Distance Between Centers	15.7" (400mm)	23.6" (600mm)	39.3" (1000mm)	59" (1500mm)	78.7" (2000mm)	Wheel Spindle	7 HP /4P (5.5 kw (4P))				
Swing Over Table	12.5" (320mm)					Workhead Spindle AC Servo Motor	1 Hp (0.8 kw)	1-3/4 Hp (1.3 kw)			
Maximum Load of Centers	220 lbs. (100kgs)					Wheel Head Feed AC Servo Motor	1-1/2 Hp (1.2 kw)				
Maximum External Grinding Diameter	11.8" (300mm)					Table Feed AC Servo Motor	2-1/2 Hp (1.8 kw)	3-1/4 Hp (2.5 kw)			
WHEEL HEAD						Hydraulic Pump	1/2 Hp /4P (0.37 kw (4P))				
Auto Rapid Advance	393 in/min (10 m/min)					Wheel Spindle Lubrication Pump	1/2 Hp /4P (0.37 kw (4P))				
Min Input Increment	0.0001 mm					Coolant Pump	1/4 Hp / 2P (.18 kw (2P))				
Internal Grinding	Manual Elevation					Internal Grinding Spindle (opt)	1 Hp / 2P (.75 kw (2P))				
GRINDING WHEEL						TANK CAPACITY					
O.D. x Width x I.D.	15.9" x 1.96" x 5" (405 x 50 x 127mm) (2.9" width optional (75mm))					Wheel Spindle Lubrication Tank	18 L				
Speed rpm	1783 rpm					Lubrication Oil Tank	18 L	42 L			
Linear Velocity	45 m/s					Coolant Tank	110 L				
WORK SPINDLE HEAD						Hydraulic Tank for OPT accessory	18 L	—			
Swivel Angle	120° (+90°, -30°)					MACHINE SIZE					
Center Taper	MT4					Net Weight	7,260 lbs. (3300 kgs)	7,920 lbs. (3600 kgs)	9,460 lbs. (4300 kgs)	10,560 lbs. (4800 kgs)	13,200 lbs. (6000 kgs)
Spindle Speeds (variable) rpm	5 – 800 rpm					Shipping Weight	8,360 lbs. (3800 kgs)	9,020 lbs. (4100 kgs)	10,560 lbs. (4800 kgs)	11,660 lbs. (5300 kgs)	14,300 lbs. (6500 kgs)
Maximum Load of Spindle (tool holder inc)	77 lbs. (35kgs) Max Length: 5.9" (150mm)					Floor Dimensions (in and mm)	134"x129"x91" (3385x3260x2300)	138"x129"x91" (3500x3260x2300)	149"x135"x91" (3765x3430x2300)	241"x126"x91" (6100x3200x2300)	304"x126"x91" (7700x3200x2300)
TAILSTOCK						Width x Depth x Work Height	42.5" (1080mm)				
Center Taper	MT4					Work Height	45.5" (1155mm)				
Stroke	0.984" (25mm)					Shipping Dimensions (in and mm)	144"x139"x101" (3635x3510x2550)	148"x139"x101" (3750x3510x2550)	158"x145"x101" (4015x3680x2550)	250"x136"x101" (6350x3450x2550)	313"x136"x101" (7950x3450x2550)
TABLE											
Swivel Angle	0°, to +12°	0°, to +12°	0°, to +10°	from -3°, to +8°	from -1°, to +7°						
Rapid feed Rate	393 in/min (10 m/min)										
Minimum Input Increment	0.0001 mm										

All specifications subject to change without notice or obligation.

CCG1616CNC, CCG1624CNC, CCG1640CNC, CCG1660CNC, CCG1680CNC



Shown with optional full splash guard

Features

- Full CNC Fanuc Oi control
- Semi Enclosed Splash Guard Standard, Full enclosed splash guard (optional)
- Swing over table 16.5" (420mm)
- Distance between centers 16" to 80" (40-2000mm)
- General Purpose Grinding Wheel
- Linear Scale for X-Axis
- Diamond Tool Dresser Table Mount Type
- Coolant System
- Hydraulic System
- Carbide tipped Work Centers
- Worklight
- Tool Box and Tools

MODEL	CCG1616CNC	CCG1624CNC	CCG1640CNC	CCG1660CNC	CCG1680CNC	MODEL	CCG1616CNC	CCG1624CNC	CCG1640CNC	CCG1660CNC	CCG1680CNC
CAPACITY						MOTOR					
Distance Between Centers	15.7" (400mm)	23.6" (600mm)	39.3" (1000mm)	59" (1500mm)	78.7" (2000mm)	Wheel Spindle	7 HP /4P (5.5 kw (4P))				
Swing Over Table	16.5" (420mm)					Workhead Spindle AC Servo Motor	1 Hp (0.8 kw)	1-3/4 Hp (1.3 kw)			
Maximum Load of Centers	330 lbs. (150kgs)					Wheel Head Feed AC Servo Motor	1-1/2 Hp (1.2 kw)				
Maximum External Grinding Diameter	15.7" (400mm)					Table Feed AC Servo Motor	2-1/2 Hp (1.8 kw)		3-1/4 Hp (2.5 kw)		
WHEEL HEAD						Hydraulic Pump	1/2 Hp /4P (0.37 kw (4P))				
Auto Rapid Advance	393 in/min (10 m/min)					Wheel Spindle Lubrication Pump	1/2 Hp /4P (0.37 kw (4P))				
Min Input Increment	0.0001 mm					Coolant Pump	1/4 Hp / 2P (.18 kw (2P))				
Internal Grinding	Manual Elevation					Internal Grinding Spindle (opt)	1 Hp / 2P (.75 kw (2P))				
GRINDING WHEEL						TANK CAPACITY					
O.D. x Width x I.D.	15.9" x 1.96" x 5" (405 x 50 x 127mm) (2.9" width optional (75mm))					Wheel Spindle Lubrication Tank	18 L				
Speed rpm	1783 rpm					Lubrication Oil Tank	18 L		42 L		
Linear Velocity	45 m/s					Coolant Tank	110 L				
WORK SPINDLE HEAD						Hydraulic Tank for OPT accessory	18 L		—		
Swivel Angle	120° (+90° , -30°)					MACHINE SIZE					
Center Taper	MT4					Net Weight	7,700 lbs. (3500 kgs)	8,360 lbs. (3800 kgs)	9,900 lbs. (4500kgs)	11,000 lbs. (5000 kgs)	13,640 lbs. (6200 kgs)
Spindle Speeds (variable) rpm	5 – 800 rpm					Shipping Weight	8,800 lbs. (4000 kgs)	10,120 lbs. (4600 kgs)	11,660 lbs. (5300 kgs)	12,760 lbs. (5800 kgs)	15,400 lbs. (7000 kgs)
Maximum Load of Spindle (tool holder inc)	77 lbs. (35kgs) Max Length: 5.9" (150mm)					Floor Dimensions (in and mm)	134"x129"x91" (3385x3260x2300)	138"x129"x91" (3500x3260x2300)	149"x135"x91" (3765x3430x2300)	241"x126"x91" (6100x3200x2300)	304"x126"x91" (7700x3200x2300)
TAILSTOCK						Width x Depth x Work Height	44.5" (1130mm)				47.5" (1205mm)
Center Taper	MT4					Work Height	44.5" (1130mm)				
Stroke	0.984" (25mm)					Shipping Dimensions (in and mm)	144"x139"x101" (3635x3510x2550)	148"x139"x101" (3750x3510x2550)	158"x145"x101" (4015x3680x2550)	250"x136"x101" (6350x3450x2550)	313"x136"x101" (7950x3450x2550)
TABLE											
Swivel Angle	0°, to +12°	0°, to +12°	0°, to +10°	from -3°, to +8°	from -1°, to +7°						
Rapid feed Rate	393 in/min (10 m/min)										
Minimum Input Increment	0.0001 mm										

All specifications subject to change without notice or obligation.

HEAVY DUTY CNC CYLINDER GRINDERS

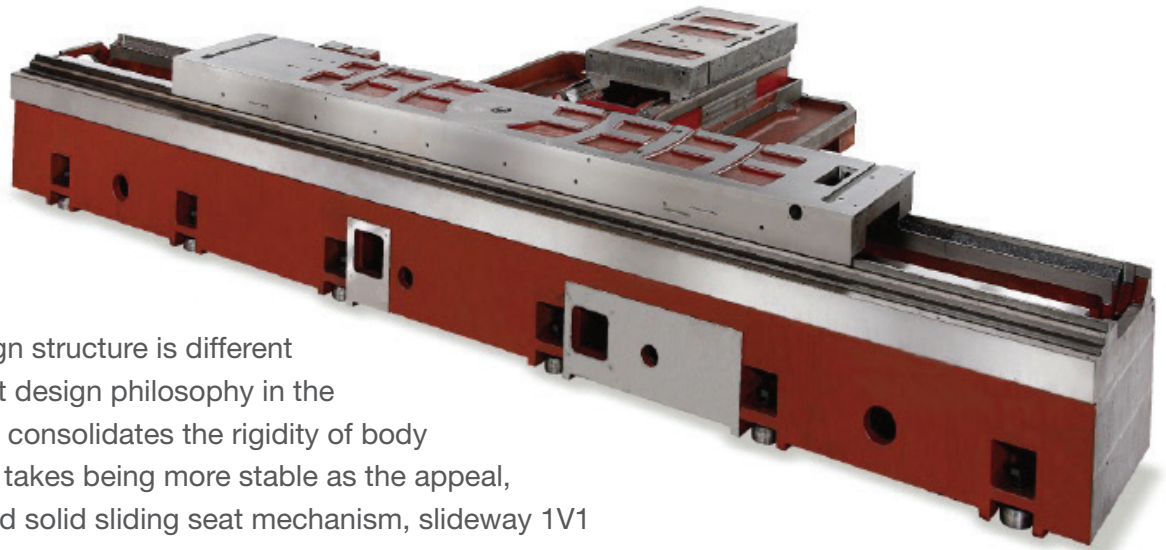

The machine's design structure is different from the light weight design philosophy in the past; it substantially consolidates the rigidity of body and parts structure, takes being more stable as the appeal, and adopts thick and solid sliding seat mechanism, slideway 1V1 flat structure, and lubrication system designed by the hydrostatic principle, providing the best precision and stability of moving with doing grinding.

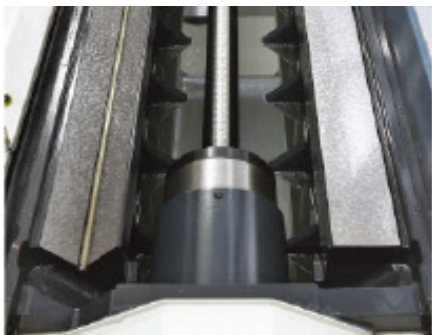

Advanced Hydro-static Lubrication System

- The slideways of the table and wheelhead are lubricated by advanced automatic hydro-static lubrication system.
- This provides various features such as extremely smooth movement, adding feeding accuracy and superior grinder accuracy.



Tailstock

- The rigid tailstock is locked on the slide firmly.
- The tailstock quill movement is driven by manual (optional hydraulic) for convenient and fast workpiece clamping and unclamping.



Rotary type Internal Grinding Attachment (optional)

- Easy to change over from O.D. to I.D. grinding. The attachment is fixed by the rotary support for convenient workpiece loading.
- To position the internal grinding attachment, simply turn it downward and fix it in the grinding position.
- Allows for external and internal grinding in one process. Tapered workpieces can be ground by swivelling on the workhead and table.



Rigid Spindle Head

- The rigid constructed spindle head employs high precision bearings assuring maximum spindle stability guaranteeing outstanding accuracy for external and internal grinding.
- The spindle head is driven by servomotor, providing variable speed change.
- The spindlehead allows for swivelling positive 90 degrees and negative 30 degrees.

CCG1840CNC, CCG1860CNC, CCG1886CNC, CCG18120CNC

CNC Heavy Duty Grinders 18"

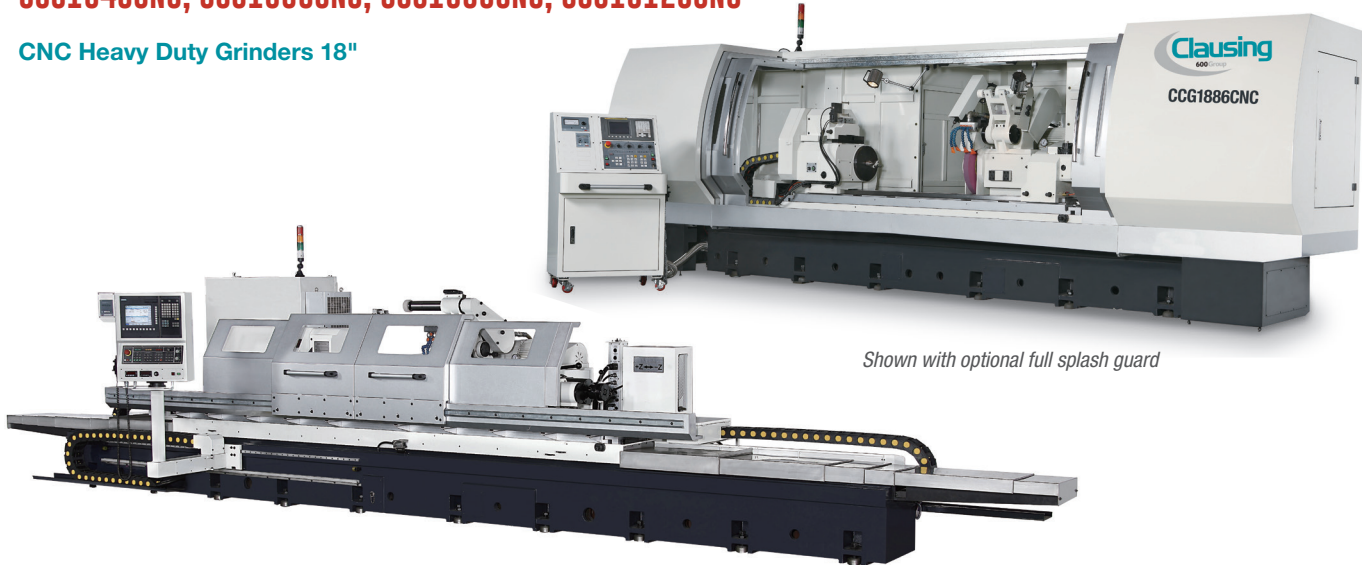

Shown with optional full splash guard

Features

- Full CNC Fanuc Oi control
- Semi Enclosed Splash Guard Standard Full enclosed splash guard (optional)
- Swing over table 17.7" (450mm)
- Distance between centers 40" to 120" (1000-3000mm)
- General Purpose Grinding Wheel
- Linear Scale for X-Axis
- Diamond Tool Dresser Table Mount Type
- Coolant System
- Hydraulic System
- G.W. Soft Starter
- Hydraulic Tank with Oil Cooler
- Worklight
- Tool Box and Tools
- Carbide tipped Work Centers

MODEL	CCG1840CN	CCCG1860CNC	CCG1886CNC	CCG18120CNC	MODEL	CCG1840CN	CCCG1860CNC	CCG1886CNC	CCG18120CNC
CAPACITY					TABLE				
Distance Between Centers	39.37" (1000mm)	59" (1500mm)	86.6" (2200mm)	118" (3000mm)	Swivel Angle	from -1°, to +7°	from -1°, to +7°	0°, to +5°	0°, to +5°
Swing Over Table	17.7" (450mm)				Rapid feed Rate	157.4 in/min (4 m/min)			
Maximum Load of Centers	1,760 lbs. (800kgs)				Minimum Input Increment	0.001 mm			
Maximum External Grinding Diameter	17.7" (450mm)				MOTOR				
WHEEL HEAD					Wheel Spindle	15 HP /4P (11 kw (4P))			
Auto Rapid Advance	157 in/min (4 m/min)				Workhead Spindle AC Servo Motor	4 Hp (3.0 kw)			
Feed Rate	0.000039 – 78.7 in/min (0.001 - 2000 mm/min)				Wheel Head Feed X-Axis AC Servo Motor	3-3/4 Hp (2.8 kw)			
Maximum Movable Distance	13.77" (350 mm)				Wheel Head Feed Z-Axis AC Servo Motor	5 Hp (4.4 kw)			
WHEEL HEAD - Z AXIS					Hydraulic Pump	1 Hp /4P (0.8 kw (4P))			
Auto Rapid Advance	157 in/min (4 m/min)				Wheel Spindle Lurication Pump	1/2 Hp /4P (0.37 kw (4P))			
Feed Rate	0.000039 – 78.7 in/min (0.001 – 2000 mm/min)				Coolant Pump	1/4 Hp / 2P (.18 kw (2P))			
Maximum Movable Distance	53.1" (1350mm)	77.5" (1970mm)	108.2" (2750mm)	142.5" (3620mm)	Internal Grinding Spindle (optional)	2 Hp / 2P (1.5 kw (2P))			
GRINDING WHEEL					TANK CAPACITY				
O.D. x Width x I.D.	20" x 1.96" x 4.9" (510 x 50 x 125mm) (6" bore optional (152.4mm))				Wheel Spindle Lubrication Tank	30 L			
Speed rpm	1236 rpm				Lubrication Oil Tank	63 L			
Linear Velocity	33 m/s				Coolant Tank	120 L			
WORK SPINDLE HEAD					Hydraulic Tank	10L			
Swivel Angle	—				MACHINE SIZE				
Center Taper	MT5				Net Weight	23,000 lbs. (10,454 kgs)	26,400 lbs. (12,000 kgs)	30,800 lbs. (14,000 kgs)	35200 lbs. (16,000 kgs)
Spindle Speeds (variable) rpm	0 – 350 rpm				Shipping Weight	26,400 lbs. (12,000 kgs)	29,876 lbs. (13,580 kgs)	34,750 lbs. (15,800 kgs)	41,140 lbs. (18,700 kgs)
Maximum Load of Spindle (tool holder inc)	—				Floor Dimensions Width x Depth x Height (in) (cm)	179"x166"x95" (455x422x242)	239"x166"x95" (607x422x242)	316"x166"x95" (803x422x242)	409"x166"x95" (1039x422x242)
TAILSTOCK					Work Height	39.37" (1000mm)			
Center Taper	MT5				Shipping Dimensions (Ft) (cm)	15.6x7.5x7.4 (475x228x224)	21.5x7.5x7.4 (655x228x224)	28x7.5x7.4 (852x228x224)	33.2x9.2x8.2 (1010x278x250)
Stroke	2.3" (60 mm)								

All specifications subject to change without notice or obligation.

HEAVY DUTY CNC CYLINDER GRINDERS

CCG2560CNC, CCG2580CNC, CCG25120CNC

CNC Heavy Duty Grinders 25"

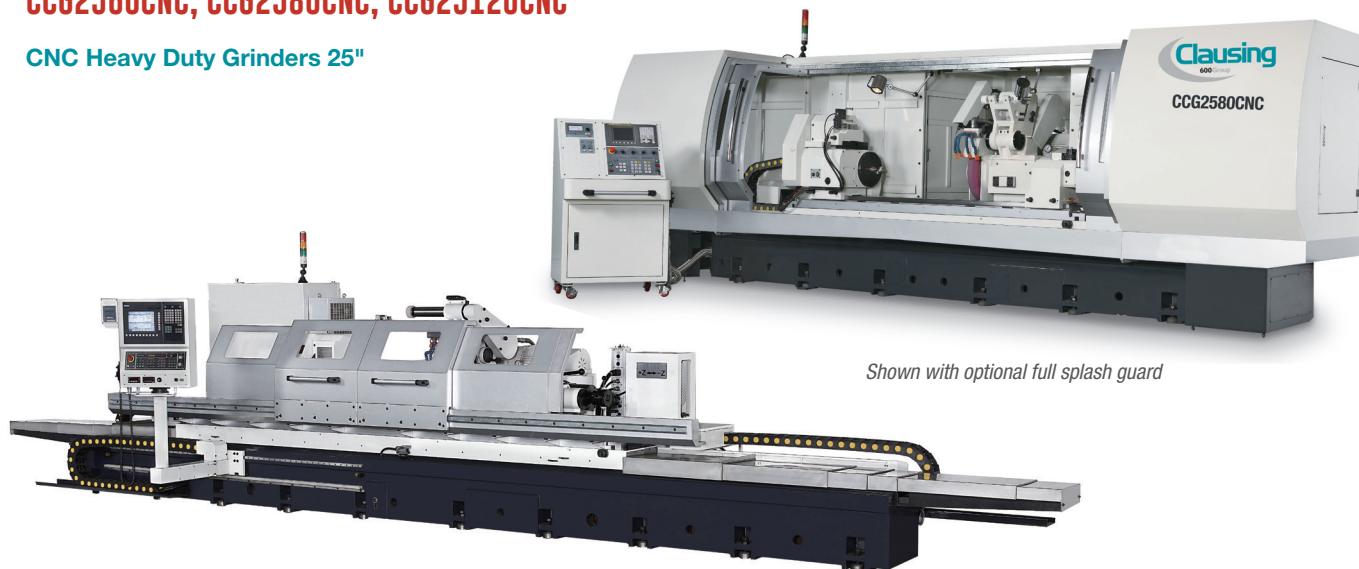

Shown with optional full splash guard

Features

- Full CNC Fanuc Oi control
- Semi Enclosed Splash Guard Standard Full enclosed splash guard (optional)
- Swing over table 25.59" (650mm)
- Distance between centers 60" to 120" (1500-3000mm)
- General Purpose Grinding Wheel
- Linear Scale for X-Axis
- Diamond Tool Dresser Table Mount Type
- Coolant System
- Hydraulic System
- G.W. Soft Starter
- Hydraulic ank with Oil Cooler
- Worklight
- Tool Box and Tools
- Carbide tipped Work Centers

MODEL	CCG2560CNC	CCG2586CNC	CCG25120CNC	MODEL	CCG2560CNC	CCG2586CNC	CCG25120CNC
CAPACITY				TABLE			
Distance Between Centers	59" (1500mm)	86.6" (2200mm)	118.1" (3000mm)	Swivel Angle	from -1°, to +7°	from -1°, to +7°	0°, to +5°
Swing Over Table	25.59" (650mm)			Rapid feed Rate	157.4 in/min (4 m/min)		
Maximum Load of Centers	4,400 lbs. (2000kgs) with HD Steady Rest			Minimum Input Increment	0.001 mm		
Maximum External Grinding Diameter	24.4" (620mm)			MOTOR			
WHEEL HEAD				Wheel Spindle	15 HP /4P (11 kw (4P))		
Auto Rapid Advance	157 in/min (4 m/min)			Workhead Spindle AC Servo Motor	4 Hp (3.0 kw)		
Feed Rate	0.000039 – 78.7 in/min (0.001 – 2000 mm/min)			Wheel Head Feed X-Axis AC Servo Motor	3-3/4 Hp (2.8 kw)		
Maximum Movable Distance	13.77" (350 mm)			Wheel Head Feed Z-Axis AC Servo Motor	5 Hp (4.4 kw)		
WHEEL HEAD - Z AXIS				Hydraulic Pump	1 Hp /4P (0.8 kw (4P))		
Auto Rapid Advance	157 in/min (4 m/min)			Wheel Spindle Lurication Pump	1/2 Hp /4P (0.37 kw (4P))		
Feed Rate	0.000039 – 78.7 in/min (0.001 - 2000 mm/min)			Coolant Pump	1/4 Hp / 2P (.18 kw (2P))		
Maximum Movable Distance	77.5" (1970mm)	108.2" (2750mm)	142.5" (3620mm)	Internal Grinding Spindle (optional)	2 Hp / 2P (1.5 kw (2P))		
GRINDING WHEEL				TANK CAPACITY			
O.D. x Width x I.D.	20" x 1.96" x 4.9" (510 x 50 x 125mm) (6" bore optional (152.4mm))			Wheel Spindle Lubrication Tank	30 L		
Speed rpm	1236 rpm			Lubrication Oil Tank	63 L		
Linear Velocity	33 m/s			Coolant Tank	120 L		
WORK SPINDLE HEAD				Hydraulic Tank	10L		
Swivel Angle	—			MACHINE SIZE			
Center Taper	MT5			Net Weight	23,000 lbs. (10,454 kgs)	26,400 lbs. (12,000 kgs)	30,800 lbs. (14,000 kgs)
Spindle Speeds (variable) rpm	0 – 350 rpm			Shipping Weight	26,400 lbs. (12,000 kgs)	29,876 lbs. (13,580 kgs)	34,750 lbs. (15,800 kgs)
Maximum Load of Spindle (tool holder inc)	—			Floor Dimensions Width x Depth x Height (in) (cm)	179"x166"x95" (455 x 422 x 242)	239"x166"x95" (607 x 422 x 242)	316"x166"x95" (803 x 422 x 242)
TAILSTOCK				Work Height	39.37" (1000mm)		
Center Taper	MT5			Shipping Dimensions (Ft) (cm)	15.6x7.5x7.4 (475 x 228 x 224)	21.5x7.5x7.4 (655 x 228 x 224)	28x7.5x7.4 (852 x 228 x 224)
Stroke	2.3" (60 mm)						

All specifications subject to change without notice or obligation.

INTERNAL GRINDING SPINDLE MANUAL, NC, AND CNC

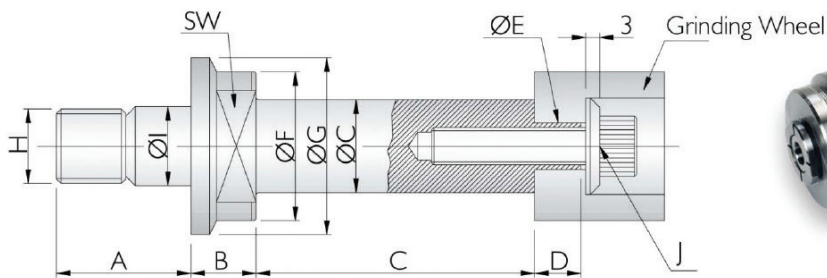

- The ratio of grinding hole diameter to length is 1 : 3.
- Maximum length is 150 mm.

Specifications

Hole Dia mm	Hole Dia IN	Grease Type	A in (mm)	B in (mm)	C in (mm)			D in (mm)	E in (mm)	F in (mm)	G in (mm)	H	I in (mm)	J	SW
65-150	2.55-5.9	8,000 rpm	1.65 (42)	0.629 (16)	40 x 100	40 x 85	40 x 55	0.472 (12)	0.472 (12)	1.968 (50)	2.283 (58)	M26 x 2.0P	1.10 (28)	M8 x 1.25P	1.614 (41)
40-80	1.57-3.14	10,000 rpm	1.14 (29)	0.551 (14)	30 x 90	25 x 70	20 x 60	0.393 (10)	0.393 (10)	1.259 (32)	1.496 (38)	M16 x 1.5P	0.669 (17)	M8 x 1.25P	0.944 (24)
35-70	1.377-2.755	15,000 rpm	1.14 (29)	0.551 (14)	30 x 90	25 x 70	20 x 60	0.393 (10)	0.393 (10)	1.259 (32)	1.496 (38)	M16 x 1.5P	0.669 (17)	M8 x 1.25P	0.944 (24)
24-40	0.944-1.57	20,000 rpm	1.10 (28)	0.433 (11)	24 x 80	26 x 60	16 x 40	0.315 (8)	0.315 (8)	1.02 (26)	1.259 (32)	M14 x 1.5P	0.59 (15)	M6 x 1.0P	0.748 (19)
15-25	0.59-0.984	30,000 rpm	0.826 (21)	0.354 (9)	16 x 40	13 x 30	10 x 25	0.236 (6)	0.236 (6)	0.826 (21)	1.02 (26)	M10 x 1.5P	0.413 (10.5)	M4 x 0.7P	0.669 (17)
12-16	0.472-0.63	40,000 rpm	0.787 (20)	0.315 (8)	12 x 35	10 x 30	8 x 25	X	X	0.708 (18)	0.905 (23)	M8 x 1.25P	0.334 (8.5)	M4 x 0.7P	0.551 (14)
9-13	0.354-0.512	50,000 rpm	0.7 (18)	0.2755 (7)	8 x 30	7 x 25	6 x 20	X	X	0.59 (15)	0.787 (20)	M7 x 1.0P	0.295 (7.5)	M4 x 0.7P	0.433 (11)



Features

- Easy to change over from O.D to I.D grinding. You must dismantel the O.D. grinding wheel first.
- To position the internal grinding attachment, simply turn it downward and fix it into the grinding position.
- Allows for external grinding and internal grinding in one process.
- Tapered workpieces can be ground by swiveling on the workhead and table.
- See specification tables for relevant horsepower ratings of internal grinding spindle.

CYLINDER GRINDER ACCESSORIES

Standard Accessories

GRINDING WHEEL AND FLANGE (1)



DIAMOND TOOL HOLDER (1)
(table mounted)



CARBIDE TIPPED WORK CENTERS (1)



WORK LIGHT (1)



TOOLS AND TOOL BOX (1)



Optional Accessories — Manual and NC Versions

INTERNAL GRINDING ATTACHMENT

(including one spindle)



DIAMOND TOOL HOLDER FOR INTERNAL AND EXTERNAL GRINDING WHEEL DRESSING

(upward open type)



DIAMOND TOOL HOLDER

(Tailstock mounted)



DIAMOND TOOL HOLDER FOR INTERNAL AND EXTERNAL GRINDING WHEEL DRESSING

(sideward open)



ANGLE TRIMMING DEVICE



RADIUS TRIMMING DEVICE



CAM LOCKED DRIVING DOGS

(6 pc set)



WORK STEADY REST

(2 pc set)



2-POINT STEADY REST



3-POINT STEADY REST



ADJUSTABLE 3-JAW SCROLL CHUCK



ADJUSTABLE 4-JAW SCROLL CHUCK



MAGNETIC COOLANT SEPARATOR



MAGNETIC COOLANT SEPARATOR WITH PAPER FILTER



WHEEL FORMING DEVICE

(manual type, without auto compensation)

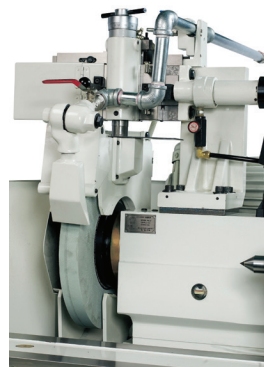

WHEEL FORMING DEVICE

(for NC model, with auto compensation)

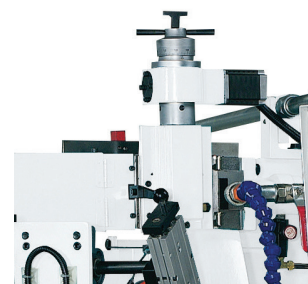

WHEEL BALANCING STAND AND ARBOR



Your Single Source for Machine Tools

Clausing Precision Drills

- Clausing Belt-drive Drills
- Clausing Geared-head Drills
- Clausing Radial Drills

Clausing Precision Mills

- Clausing Bed Mills
- Clausing CNC Bed Mills
- Clausing Knee Mills
- Clausing EVS Knee Mills
- Clausing CNC Knee Mills
- Clausing Universal Mills

Clausing Precision Lathes

- Clausing/Colchester Geared Head Lathes
- Clausing/Colchester Professional V.S. Lathes
- Clausing/Colchester MAGNUM V.S. Lathes
- Clausing C Series Lathes
- Clausing Large Swing Standard Lathes
- Clausing Large Swing CNC Lathes
- Clausing Precision Toolroom Lathes

Clausing Precision Grinders

- Clausing Manual Grinders
- Clausing 2 Axes Hydraulic Grinders
- Clausing 3 Axes Hydraulic Grinders
- Clausing ASDIII Automatic Grinders
- Clausing OD/ID Grinders
- Clausing Cylinder Grinders

Clausing Precision Cutting Machines

- Clausing/Kalamazoo Horizontal Bandsaws
- Clausing/Kalamazoo Vertical Bandsaws
- Clausing/Kalamazoo Tilt Frame Miter Bandsaws
- Clausing/Kalamazoo Cold Saws



For detailed catalogs of the full line of Clausing Machine Tools visit our Web Site:

www.clausing-industrial.com

Fax: 269-345-5945 or e-mail us and request an electronic (pdf) catalog at:

info@clausing-industrial.com

Your Authorized Clausing Precision Machine Tools Distributor

