



Variable Speed Lathes
13", 15", 18", 21", 26" and 32" Swing

Geared Head Lathes
13" and 15" Swing



COLCHESTER LATHES

AFFORDABLE. DURABLE. VERSATILE.

A line of precision, high-performance geared head and variable speed lathes built for demanding turning applications.

13" & 15" Variable Spindle Drive Power Charts

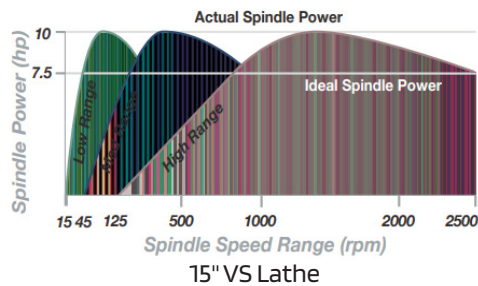
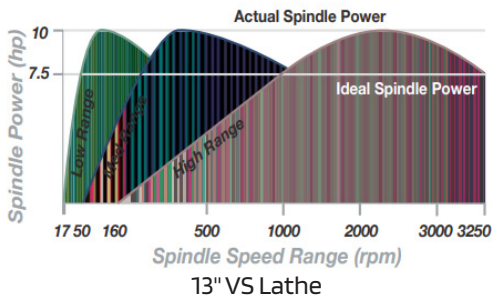

CLAUSING/COLCHESTER 13" (320MM)



The extra heavy-duty, wide bed allows our machines to withstand heavy use, offering excellent durability and requiring minimal maintenance over many years.

CLAUSING/COLCHESTER 15" (400MM)

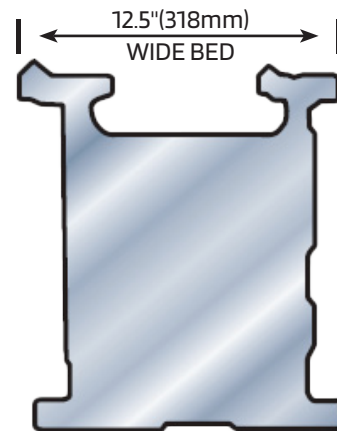

Features

- State-of-the-art AC Spindle Drive features surface mount technology to give compact size and high reliability
- Interlocked end guard door for easy access for maintenance and changing end train gears
- Faster thread cutting — reversal of the leadscrew with the spindle running at low speed
- An easy-to-read index plate, makes it simple to select the proper feed or threads
- Three headstock gear ranges produce a wide spread of constant power — 33 to 1 — better than most CNC lathes
- Infinitely variable spindle speeds displayed on the headstock
- Dynamic spindle brake via the inverter
- Spindle bearings, gears, and shafts are lubricated through a forced lubrication system
- Precision tapered roller spindle bearings

- Chuck guard with limit switch
- Carriage ways coated with "Moglice" PTFE for minimal bedwear and longer machine life
- Saddle mounted chip guard and full rear splash guard
- Extra wide heavy-duty cast iron bed with triangular webs for torsional stiffness and excellent chip clearance
- Heavy-duty tailstock with extra heavy-duty quill
- Single piece leadscrew cover protects leadscrew from chips
- Large capacity rollout chip bin for easy chip disposal
- All bedways are induction hardened and precision ground
- Heavyweight cast iron bases provide the maximum support for the bed combined with sloping top surfaces to prevent the accumulation of coolant
- 13" machines have 25", 40", and 50" center distances
- 15" machines have 25", or 50" center distances

CLAUSING/COLCHESTER 18" (460MM) 21" (554MM)



Features

- State-of-the-art AC Spindle Drive features surface mount technology to give compact size and high reliability
- Interlocked end guard door for easy access for maintenance and changing end train gears
- Faster thread cutting — reversal of the leadscrew with the spindle running at low speed
- An easy-to-read index plate makes it simple to select the proper feed or threads
- Three headstock gear ranges produce a wide spread of constant power — 33 to 1 — better than most CNC lathes
- Infinitely variable spindle speeds displayed on the headstock
- Dynamic spindle brake via the inverter
- Spindle bearings, gears, and shafts are lubricated through a forced lubrication system
- Precision tapered roller spindle bearings
- Chuck guard with limit switch
- Carriage ways coated with "Moglice" PTFE for minimal bedwear and longer machine life
- Saddle mounted chip guard and full rear splash guard
- Extra wide heavy-duty cast iron bed with triangular webs for torsional stiffness and excellent chip clearance
- 2 axis power rapid traverse available from one lever mounted on the saddle
- Heavy-duty tailstock with extra heavy-duty quill
- Single piece leadscrew cover protects leadscrew from chips
- Large capacity rollout chip bin for easy chip disposal
- All bedways are induction hardened and precision ground
- Heavyweight cast iron bases provide the maximum support for the bed combined with sloping top surfaces to prevent the accumulation of coolant
- 18" machines have 40", 60" or 80" center distances
- 21" machines have 40", 60", 80", or 120" center distances

18" & 21" Variable Spindle Drive Power Charts

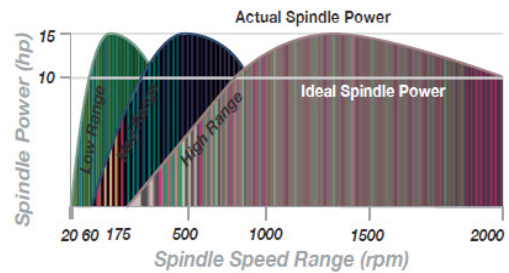

18" VS Lathe

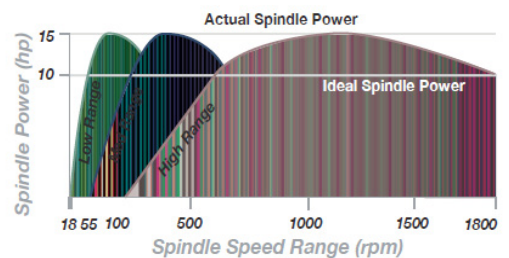

21" VS Lathe

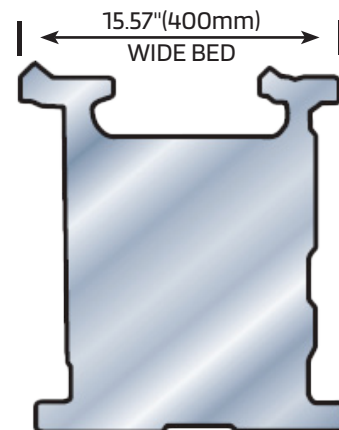

CLAUSING/COLCHESTER 13" (320MM)



CLAUSING/COLCHESTER 15" (400MM)



Clausing/Colchester Geared Head and Variable Speed lathes are recognized as the industry standard due to the quality built into every machine translating into real long-term performance for your application. With rugged construction, consistent quality in design and production, and our 'human engineering,' our lathes make operators more efficient, resulting in a cost-effective investment. Operators have trusted Clausing Industrial Lathes for over a century and continue to do so for their unmatched machine performance.

Features

- Fully-geared headstock having:
 - 13" machine — 12 spindle speeds with 40–2500 RPM
 - 15" machine — 16 spindle speeds with 25–2000 RPM with soft start system
- All headstock gears are hardened and ground
- Headstock shafts are splined and turn on anti-friction bearings
- Spindle bearings, gears, and shafts are lubricated through a forced lubrication system
- A broad range of feed and thread selections are available by using three selector levers and an 8-position rotary dial
- Cross slide runs along a dovetail guide
- Precision tapered roller spindle bearings
- Bed wipers and an apron-mounted one-shot lubrication pump
- The cast iron apron is fully enclosed and splash-bath lubricated
- Electromagnetic spindle brake
- 13" machines have 25", 40", and 50" center distances
- 15" machines have 25" or 50" center distances
- Equipped with chuck guard, full splash guard, and leadscrew cover
- Clutch drive — reverse leadscrew with spindle turning for faster thread cutting
- Extra wide bed provides accuracy and minimal wear
- A one-year warranty backed by the Clausing Service Center dedicated to supporting our customers with parts and service

MODELS (Model # See Below)	13" VS	15" VS	18" VS	21" VS	13" GH	15" GH
CAPACITY						
Height of Center	6.7" (170mm)	7.67" (195mm)	9" (229mm)	11.02" (280mm)	6.5" (167mm)	7.68" (195mm)
Swing Over Bed	13.75" (350mm)	15.75" (400mm)	18.1" (460mm)	21.81" (554mm)	13" (330mm)	15.75" (400mm)
Swing in Gap	21" (533mm)	23" (584mm)	28.74" (730mm)	32.68" (830mm)	18.8" (480mm)	23" (585mm)
Width in Front of Faceplate	6.5" (165mm)	6.5" (165mm)	8.5" (216mm)	8.5" (216mm)	4.5" (115mm)	6.5" (165mm)
Swing Over Cross Slide	7.75" (197mm)	9.7" (246mm)	10.62" (216mm)	14.57" (370mm)	8.26" (210mm)	9.7" (246mm)
Bedway Width	12.5" (318mm)	12.5" (318mm)	15.75" (400mm)	15.75" (400mm)	8" (203mm)	12.5" (318mm)
HEADSTOCKS						
Spindle Bore	1.65" (42mm)	2.12" (54mm)	3" (76mm)	4.09" (104mm)	1.57" (40mm)	2.12" (54mm)
Spindle Nose (Camlock)	D1-4	D1-6	D1-8	D1-11	D1-4	D1-6
Spindle Nose Taper	3MT	4MT	5MT	5MT	3MT	4MT
Number of Spindle Speeds	3 Infinitely Variable	3 Infinitely Variable	3 Infinitely Variable	3 Infinitely Variable	12	16
Spindle Speed Range (RPM)	15-3250	15-2500	20-2000	18-1800	40-2500	25-2000
Low Range	15-340	15-300	20-225	18-200	-	-
Medium Range	40-1010	35-830	60-675	55-605	-	-
High Range	150-3250	110-2500	175-2000	160-1800	-	-
CROSS/TOP SLIDE						
Travel of Cross Slide	9.8" (249mm)	9.8" (249mm)	11.81" (299mm)	11.81" (299mm)	7.5" (190mm)	9.8" (250mm)
Width of Cross Slide	7.09" (180mm)	7.09" (180mm)	8" (203mm)	8" (203mm)	5.5" (140mm)	7.09" (180mm)
Travel of Top Slide	5.5" (140mm)	5.1" (130mm)	7.5" (190mm)	7.5" (190mm)	3.63" (92mm)	5.1" (130mm)
Width of Top Slide	3.54" (90mm)	3.93" (100mm)	4" (102mm)	4" (102mm)	3.25" (82mm)	3.93" (100mm)
TAILSTOCK						
Quill Travel	5.5" (140mm)	5.5" (140mm)	5.7" (145mm)	5.7" (145mm)	4.38" (110mm)	5.5" (140mm)
Quill Diameter	2.48" (63mm)	2.87" (73mm)	3.74" (95mm)	3.74" (95mm)	1.63" (42mm)	2.8" (73mm)
Quill Taper	4MT	5MT	6MT	6MT	3MT	5MT
FEEDS AND THREADING						
Longitudinal Feed Range (in/rev)	0.0014-0.048	0.0014-0.048	0.0016-0.11	0.0016-0.11	0.001-0.080	0.0014-0.096
mm/rev	0.35-1.22	0.35-1.22	0.41-2.79	0.41-2.79	0.30-2.00	0.35-2.45
Cross Feed Range (in/rev)	0.0007-0.024	0.00035-0.024	0.0008-0.055	0.0008-0.055	-	0.0007-0.048
mm/rev	0.018-0.61	0.0089-0.61	0.02-1.4	0.02-1.4	-	0.018-1.22
Number of Inch Pitches	56	56	73	73	35	56
Range of Inch Pitches	2-56 TPI	2-56 TPI	2-84 TPI	2-84 TPI	2-56 TPI	2-56 TPI
Number of Metric Pitches	20	51	51	27	39	51
Range of Metric Pitches	0.2-14mm	0.2-14mm	0.2-14mm	0.2-14mm	0.2-14mm	0.2-14mm
Number of Diametral Pitches	20	20	27	27	18	20
Range of Diametral Pitches	8-56 DP	8-56 DP	8-72 DP	8-56 DP	8-56 DP	
Number of Module Pitches	51	20	27	51	18	20
Range of Module Pitches	0.2-3.5 MOD	0.2-3.5 MOD	0.2-3.5 MOD	0.2-3.5 MOD	0.2-3.5 MOD	0.2-3.5 MOD
MOTOR						
Spindle Motor	10Hp (7.5kw)	10Hp (7.5kw)	15Hp (10kw)	15Hp (10kw)	3Hp (2.2kw)	7.5Hp (5kw)

- ### Standard Features
- Spindle center bushing
 - Two Morse Taper dead centers
 - Rear splash guard
 - Tool post chip guard
 - Interlock chuck guard
 - Leadscrew cover
 - Inch threading dial
 - Electric coolant pump, tank, and fitting, coolant system
 - End guard limit switch
 - Tee slotted top slide
 - Set of wrenches and keys
 - Instruction and parts manual
 - Accuracy chart
 - Emergency stop button
 - Lockable isolator switch
 - One shot saddle and cross slide lubrication
 - Rapid power traverse to cross slide and carriage (18" & 21" V.S. models)
 - Saddle mounted controls and power meter (18" & 21" V.S. models)
 - Forward/Reverse/Stop lever
 - 230/460 v 3ph standard on VS models All other voltage require an optional transformer
 - 230/460 v. 3 ph standard on Geared Head models
 - Models 8026J/8027J Geared Head lathes are available with 220 v. 1 ph

Due to ongoing design improvements, specifications and design are subject to change without notice.

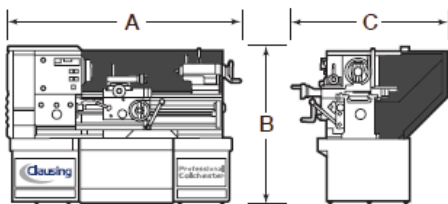

SIZE	MODEL	CENTER DISTANCE	MACHINE SIZE			NET WEIGHT	SHIPPING WEIGHT
			A	B	C		
13" GH	8026J	25" (635mm)	59" (1500mm)	51" (1300mm)	35" (890mm)	1,562 lbs. (710kg)	1,680 lbs. (762kg)
	8027J	40" (1016mm)	75" (1900mm)	51" (1300mm)	35" (890mm)	1,738 lbs. (790kg)	1,892 lbs. (790kg)
13" VS	8016VSJ	25" (635mm)	75" (1900mm)	51" (1300mm)	44" (1120mm)	2,970 lbs. (1350kg)	3,168 lbs. (1440kg)
	8017VSJ	50" (1270mm)	99" (2500mm)	51" (1300mm)	44" (1120mm)	3,300 lbs. (1500kg)	3,960 lbs. (1800kg)
15" GH	8042	25" (635mm)	75" (1900mm)	63" (1600mm)	44" (1120mm)	2,970 lbs. (1350kg)	3,168 lbs. (1440kg)
	8043SS	50" (1270mm)	99" (2500mm)	63" (1600mm)	44" (1120mm)	3,300 lbs. (1500kg)	3,960 lbs. (1800kg)
15" VS	8041VSJ	25" (635mm)	75" (1900mm)	63" (1600mm)	44" (1120mm)	2,970 lbs. (1350kg)	3,168 lbs. (1440kg)
	8044VSJ	50" (1270mm)	99" (2500mm)	63" (1600mm)	44" (1120mm)	3,300 lbs. (1500kg)	3,960 lbs. (1800kg)
18" VS	8053VSJ	40" (1016mm)	100" (2540mm)	56" (1425mm)	57" (1450mm)	4,576 lbs. (2080kg)	5,236 lbs. (2380kg)
	8054VSJ	60" (1500mm)	120" (3000mm)	56" (1425mm)	57" (1450mm)	5,676 lbs. (2580kg)	6,336 lbs. (2880kg)
	8055VS	80" (2000mm)	140" (3556mm)	56" (1425mm)	57" (1450mm)	6,160 lbs. (2800kg)	6,820 lbs. (3100kg)
21" VS	8114VSJ	40" (1016mm)	100" (2540mm)	63" (1600mm)	57" (1450mm)	4,576 lbs. (2080kg)	5,236 lbs. (2380kg)
	8115VSJ	60" (1500mm)	120" (3000mm)	63" (1600mm)	57" (1450mm)	5,676 lbs. (2580kg)	6,336 lbs. (2880kg)
	8116VSJ	80" (2000mm)	140" (3556mm)	63" (1600mm)	57" (1450mm)	6,270 lbs. (2850kg)	6,930 lbs. (3150kg)
	8119VSJ	120" (3000mm)	180" (4572mm)	63" (1600mm)	57" (1450mm)	7,942 lbs. (3610kg)	8,580 lbs. (3900kg)

CLAUSING/COLCHESTER 'MAGNUM' 26" (660MM)



CLAUSING/COLCHESTER 'MAGNUM' 32" (813MM)

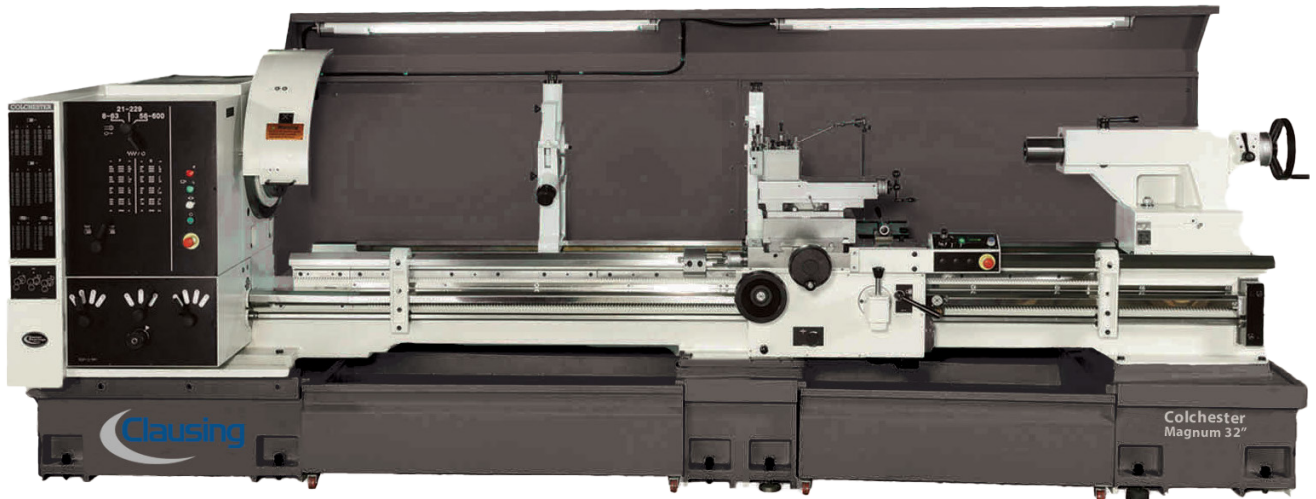

Features

- AC inverter variable speed spindle drive: State-of-the-art AC spindle drive featuring surface mount technology for compact size and high reliability.
- Interlocked end guard door with easy access for maintenance and changing end train gears
- Leadscrew reversing box for faster thread cutting — reversal of the leadscrew with the spindle running at low speed
- Easy to read index plate makes it simple to select the proper feed rate or threads
- Three headstock gear ranges are available to produce constant power — 33 to 1 — better than most CNC lathes
- Infinitely variable spindle speeds: Achieve the right spindle speed quickly with CNC-like responsiveness, displayed directly on the headstock.
- Dynamic spindle brake via the inverter
- Forced lubrication system the spindle bearings, gears and shafts are lubricated by a forced lubrication system
- Precision tapered roller spindle bearings
- Chuck guard with limit switch

- Anti-friction carriage ways. Low-friction "Moglice" PTFE material between the saddle and bed for minimal bedwear and longer machine life
- Saddle mounted chip guard and full rear splash guard
- 2 axis power rapid traverse available from one lever mounted on the saddle
- Extra wide, heavy-duty cast iron bed with triangular webs for exceptional torsional stiffness and excellent chip clearance
- Heavy-duty tailstock for excellent rigidity — with an extra heavy-duty quill
- Covered leadscrew protects leadscrew from chips
- Wheeled chip bin has a large capacity for easy chip disposal
- Hardened and ground bedways — all bedways are induction hardened and precision ground
- Cast iron base provides the maximum support for the bed combined with sloping top surfaces to prevent the accumulation of coolant
- 26" machines have 60", 80", 120", and 160" center distances
- 32" machines have 60", 80", 120", 160", 200", and 240" center distances

MODELS	MAGNUM 26"	MAGNUM 32"
CAPACITY		
Height of Center	46.65" (1185mm)	49.68" (1262mm)
Swing Over Bed	26.3" (670mm)	32.3" (820mm)
Swing in Gap	35.8" (910mm)	41.7" (1060mm)
Width in Front of Gap	9.44" (240mm)	
Swing Over Cross Slide	16.9" (430mm)	22.8" (580mm)
Bedway Width	18.9" (480mm)	
CROSS/TOP SLIDE		
Travel of Cross Slide	16" (406mm)	
Width of Cross Slide	11" (280mm)	
Travel of Top Slide	6.5" (165mm)	
Width of Top Slide	7" (180mm)	
TAILSTOCK		
Quill Travel	12" (300mm)	
Quill Diameter	4.125" (105mm)	
Quill Taper	6MT	
FEEDS AND THREADING		
Longitudinal Feed Range (in/rev)	0.002-0.16	
(mm/rev)	0.05-3.2	
Cross Feed Range (in/rev)	0.001-0.08	
(mm/rev)	0.025-1.6	
Number of Inch Pitches	51	
Range of Inch Pitches	2-84 TPI	
Number of Metric Pitches	59	
Range of Metric Pitches	0.2-14mm	
Number of Diametral Pitches	27	
Range of Diametral Pitches	8-72	
Number of Module Pitches	20	
Range of Module Pitches	0.2-3.5	
MOTOR		
Spindle Hp	30 (20kw)	
Coolant Hp	1/2	

Due to ongoing design improvements, specifications and design are subject to change without notice.

Standard Features

- Spindle center bushing
- Two MT centers
- Rear splash guard
- Interlock chuck guard
- Leadscrew cover
- Coolant system
- Inch threading dial
- Rapid power traverse to cross slide and carriage
- Saddle mounted controls and power meter
- Tee slotted top slide
- Tool post chip guard
- Set of wrenches and keys
- Instruction and parts manual
- Accuracy chart
- Emergency stop button
- Lockable isolator switch
- One-shot saddle and cross slide lubrication
- forward/reverse/stop lever
- Standard 230/3/60 or 460/3/60 volts (208/3/60 volts require a transformer)

MODEL	SWING AND CENTER DISTANCE	A	B	C	WEIGHT APPROX
8215VSJ	26" x 60" 600mm x 1500mm	151.5" 3850mm	70.8" 1800mm	74.8" 1900mm	8,820 lbs. 4000kg
8216VSJ	26" x 80" 600mm x 2023mm	171.2" 4350mm	70.8" 1800mm	74.8" 1900mm	9,480 lbs. 4300kg
8219VSJ	26" x 120" 600mm x 3048mm	210" 5350mm	70.8" 1800mm	74.8" 1900mm	11,245 lbs. 5100kg
8220VSJ	26" x 160" 600mm x 4064mm	250" 6350mm	70.8" 1800mm	74.8" 1900mm	12,785 lbs. 5800kg
8221VSJ	26" x 200" 600mm x 5000mm	289.4" 7350mm	70.8" 1800mm	74.8" 1900mm	14,388 lbs. 6540kg
8222VSJ	26" x 240" 600mm x 6000mm	328.7" 8350mm	70.8" 1800mm	74.8" 1900mm	20,416 lbs. 9280kg
8315VSJ	32" x 60" 813mm x 1500mm	151.5" 3850mm	70.8" 1800mm	74.8" 1900mm	10,362 lbs. 4700kg
8316VSJ	32" x 80" 813mm x 2032mm	171.2" 4350mm	70.8" 1800mm	74.8" 1900mm	11,464 lbs. 5200kg
8319VSJ	32" x 120" 813mm x 3048mm	210" 5350mm	70.8" 1800mm	74.8" 1900mm	14,109 lbs. 6400kg
8320VSJ	32" x 160" 813mm x 4064mm	250" 6350mm	70.8" 1800mm	74.8" 1900mm	16,535 lbs. 7500kg
8321VSJ	32" x 200" 813mm x 5000mm	289.4" 7350mm	70.8" 1800mm	74.8" 1900mm	16,808 lbs. 7640kg
8322VSJ	32" x 240" 813mm x 6000mm	328.7" 8350mm	70.8" 1800mm	74.8" 1900mm	22,836 lbs. 10380kg

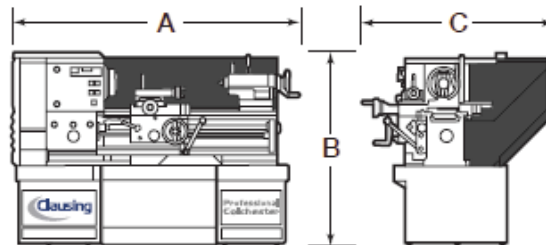

HEADSTOCK	26" STANDARD	26" OPTION #1	32" STANDARD	32" OPTION #1	32" OPTION #2
Spindle Bore	4.09" (104mm)	6" (155mm)	4.09" (104mm)	6.1" (104mm)	9.05" (230mm)
Spindle Nose (Camlock)	D1-T1	A2-T1	D1-T1	A2-T1	A2-T5
Spindle Nose Taper	8MT	7MT w/ Sleeve	8MT	7MT w/ Sleeve	-
Number of Spindle Speeds	3	3	3	3	3
Spindle Speed Range (RPM)	18-1800	15-800	18-1800	15-800	8-600
Low Range (RPM)	18-200	15-102	18-200	15-102	8-63
Medium Range (RPM)	55-605	45-306	55-605	45-306	21-229
High Range (RPM)	160-1800	118-800	160-1800	118-800	56-600

CLAUSING/COLCHESTER HEAVY DUTY 'MAGNUM' 32" (813MM)

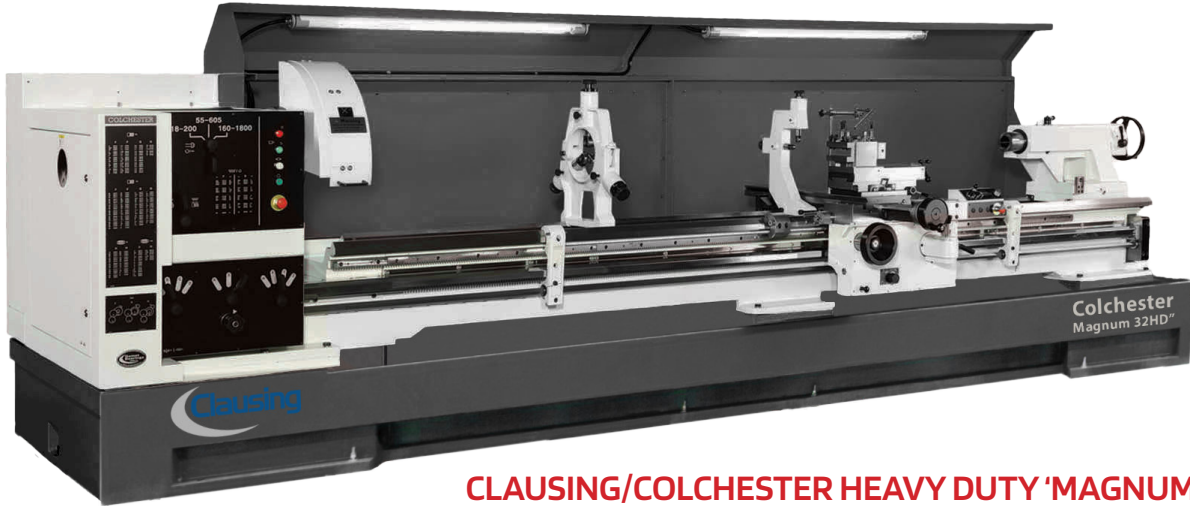

CLAUSING/COLCHESTER HEAVY DUTY 'MAGNUM' 40" (1016MM)

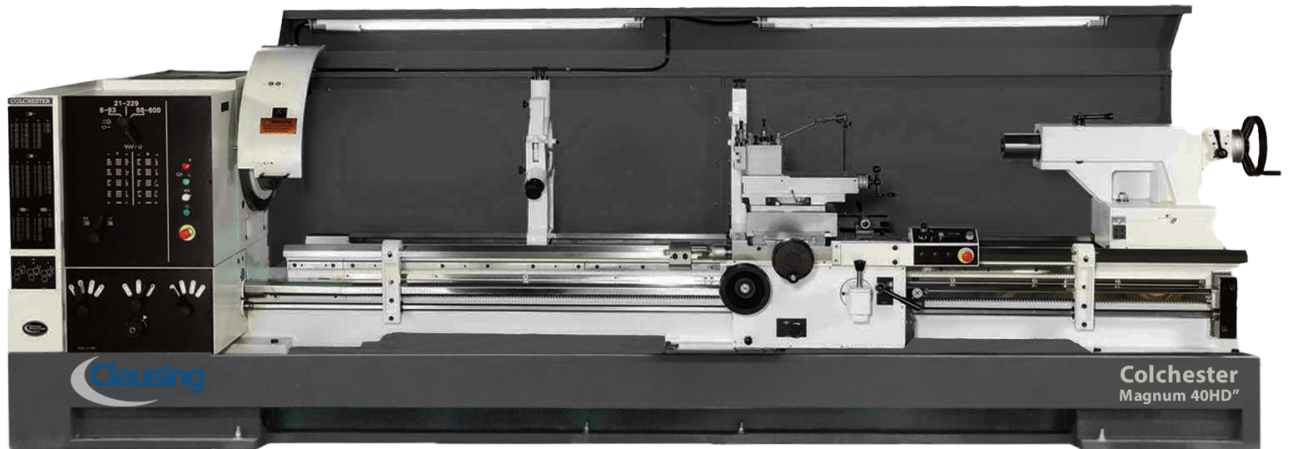

Features

- AC inverter variable speed spindle drive: State-of-the-art AC spindle drive featuring surface mount technology for compact size and high reliability.
- Interlocked end guard door with easy access for maintenance and changing end train gears
- Leadscrew reversing box for faster thread cutting — reversal of the leadscrew with the spindle running at low speed
- Easy to read index plate makes it simple to select the proper feed rate or threads
- Three Headstock Gear Ranges are available to produce constant power — 33 to 1 — better than most CNC lathes
- Infinitely variable spindle speeds: Achieve the right spindle speed quickly with CNC-like responsiveness, displayed directly on the headstock.
- Dynamic spindle brake via the inverter
- Forced lubrication system the spindle bearings, gears and shafts are lubricated by a forced lubrication system
- Precision tapered roller spindle bearings
- Chuck guard with limit switch
- Anti-friction carriage ways. Low-friction "Moglice" PTFE material between the saddle and bed for minimal bedwear and longer machine life
- Saddle mounted chip guard and full rear splash guard
- 2 axis power rapid traverse available from one lever mounted on the saddle
- Extra wide, heavy-duty cast iron bed with triangular webs for exceptional torsional stiffness and excellent chip clearance
- Heavy-duty tailstock for excellent rigidity — with extra heavy-duty quill
- Covered leadscrew protects leadscrew from chips
- Wheeled chip bin has a large capacity for easy chip disposal
- Hardened and ground bedways — all bedways are induction hardened and precision ground
- Cast iron base provides the maximum support for the bed combined with sloping top surfaces to prevent the accumulation of coolant
- 32" and 40" machines have 80", 120", 160", 200", and 240" center distances

MODELS	H.D. MAGNUM 32"	H.D. MAGNUM 40"
CAPACITY		
Height of Center	47.24" (1200mm)	51.18" (1300mm)
Swing Over Bed	31.4" (800mm)	39.3" (1000mm)
Swing in Gap	43.3" (1100mm)	51.1" (1300mm)
Gap Width from Spindle Nose	22.2" (564mm)	
Swing Over Cross Slide	20.07" (510mm)	27.9" (710mm)
Bedway Width	22.04" (560mm) 3V	
CROSS/TOP SLIDE		
Travel of Cross Slide	19.68" (500mm)	
Width of Cross Slide	11.81" (300mm)	
Travel of Top Slide	6.49" (165mm)	
Width of Top Slide	7" (180mm)	
TAILSTOCK		
Quill Travel	10.8" (275mm)	
Quill Diameter	4.9" (125mm)	
Quill Taper	6MT	
FEEDS AND THREADING		
Longitudinal Feed Range (in/rev)	0.0019-0.125	
(mm/rev)	0.05-3.2	
Cross Feed Range (in/rev)	0.00098-0.0629	
(mm/rev)	0.025-1.6	
Number of Inch Pitches	51	
Range of Inch Pitches	2-84 TPI	
Number of Metric Pitches	59	
Range of Metric Pitches	0.2-14mm	
Number of Diametral Pitches	27	
Range of Diametral Pitches	8-72	
Number of Module Pitches	20	
Range of Module Pitches	0.2-3.5	
MOTOR		
Spindle Hp	30 (20kw)	
Coolant Hp	1/2	

Due to ongoing design improvements, specifications and design are subject to change without notice.

Standard Features

- Spindle Center Bushing
- Two MT Centers
- Rear Splash Guard
- Interlock Chuck Guard
- Leadscrew Cover
- Coolant System
- Inch Threading Dial
- Rapid Power Traverse to Cross Slide and Carriage
- Saddle Mounted Controls and Power Meter
- Tee Slotted Top Slide
- Tool Post Chip Guard
- Set of Wrenches and Keys
- Instruction and Parts Manual
- Accuracy Chart
- Emergency Stop Button
- Lockable Isolator Switch
- One Shot Saddle and Cross Slide Lubrication
- Forward/Reverse/Stop Lever
- Standard 230/3/60 or 460/3/60 Volts (208/3/60 volts Require a Transformer)

MODEL	SWING AND CENTER DISTANCE	A	B	C	WEIGHT APPROX
8316VSJHD	32" x 80" 813mm x 2000mm	192.9" 4900mm	74.8" 1900mm	82.67" 2100mm	17,050 lbs. 7750kg
8319VSJHD	32" x 120" 813mm x 3000mm	233" 5920mm	74.8" 1900mm	82.67" 2100mm	18,590 lbs. 8450kg
8320VSJHD	32" x 160" 600mm x 3048mm	273.2" 6940mm	74.8" 1900mm	82.67" 2100mm	20,130 lbs. 9150kg
8321VSJHD	32" x 200" 600mm x 4064mm	313.38" 7960mm	74.8" 1900mm	82.67" 2100mm	21,670 lbs. 9850kg
8322VSJHD	32" x 240" 813mm x 6000mm	353.5" 8980mm	74.8" 1900mm	82.67" 2100mm	23,210 lbs. 10550kg
8416VSJHD	40" x 80" 1000mm x 2000mm	192.9" 4900mm	74.8" 1900mm	82.67" 2100mm	17,050 lbs. 7750kg
8419VSJHD	40" x 120" 1000mm x 3000mm	233" 5920mm	74.8" 1900mm	82.67" 2100mm	18,590 lbs. 8450kg
8420VSJHD	40" x 160" 1000mm x 4000mm	273.2" 6940mm	74.8" 1900mm	82.67" 2100mm	20,130 lbs. 9150kg
8421VSJHD	40" x 200" 1000mm x 5000mm	313.38" 7960mm	74.8" 1900mm	82.67" 2100mm	21,670 lbs. 9850kg
8422VSJHD	40" x 240" 1000mm x 6000mm	353.5" 8980mm	74.8" 1900mm	82.67" 2100mm	23,210 lbs. 10550kg

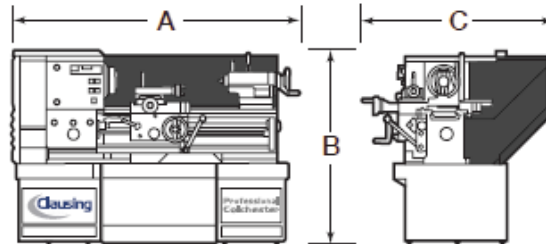

HEADSTOCK	32" STANDARD	32" OPTION #1	32" OPTION #2	40" STANDARD	40" OPTION #1	40" OPTION #2	40" OPTION #3
Spindle Bore	6.1" (155mm)	9.8" (250mm)	12" (305mm)	6.1" (155mm)	9.8" (250mm)	12" (305mm)	14.9" (380mm)
Spindle Nose Type	A2-11	A2-15	A2-20	A2-11	A2-15	A2-20	A2-20
Number of Spindle Speeds	4	4	4	4	4	4	4
Spindle Speed Range (RPM)	6-800	4-600	4-400	6-800	4-600	4-400	4-300

LIVE CENTER

Revolving center is concentric within 0.0002" T.I.R. 60°



Part No.	Fits Lathe Models	Weight
12-510	13" Swing Geared Head Lathes	2 lbs.
15-710	13" Swing Variable Speed Lathes	3 lbs.
17-910	15" Swing Geared Head & Variable Speed Lathes	9 lbs.
18-910	18" through 32" Swing Variable Speed Lathes	9 lbs.

LED WORK LIGHT

FV-9070L
Weight 5 lbs.



TAPER ATTACHMENT

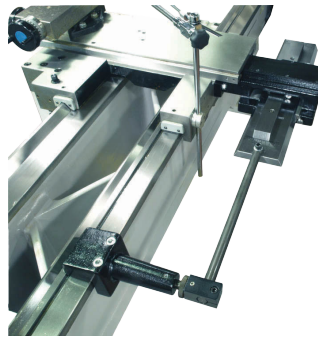

The taper attachment is fitted to the rear of the carriage and permits taper turning without dis-engaging the cross feed screw. It is easy to set-up and does not interfere with normal operation. The slide is graduated in degrees of taper with a range of 10° on either side of center. Maximum taper is 4" per foot.

Part No.	Fits Lathe Models	Capacity Per Setting	Weight
3-521	13" Swing Geared Head Lathes	10"	39 lbs.
13-410VS	13" & 15" Swing Geared Head & Variable Speed Lathes	12"	39 lbs.
18-810	18" & 21" Swing Variable Speed Lathes	15"	94 lbs.
26-810	26" Swing Variable Speed Lathes	15"	105 lbs.
32-810	32" Swing Variable Speed Lathes	15"	105 lbs.

STEADY REST

The steady rest provides support for long or slender work pieces and allows heavy cuts without chatter. Capacities are sized for lathe models.



Part No.	Fits Lathe Models	Capacity Min-Max	Fingers	Weight
3-513	13" Swing Geared Head Lathes	0.375"-5.5"	Bronze	37 lbs.
13-472VS	13" Swing Variable Speed Lathes	0.375"-5.5"	Bronze Tip & Roller	37 lbs.
15-755N	15" Swing Geared Head & Variable Speed Lathes	0.375"-6.375"	Bronze Tip & Roller	45 lbs.
18-812	18" Swing Variable Speed Lathes	0.375"-9.375"	Bronze Tip & Roller	58 lbs.
21-860	21" Swing Variable Speed Lathes	6.125"-15"	Bronze Tip & Roller	115 lbs.
21-412VS	21" Swing Variable Speed Lathes	0.375"-9"	Bronze Tip & Roller	115 lbs.
26-412VS	26" Swing Variable Speed Lathes	1.9"-8.26"	Roller Tip	115 lbs.
26-860	26" Swing Variable Speed Lathes	7.8"-14.9"	Roller Tip	125 lbs.
32-412VS	32" Swing Variable Speed Lathes	1.9"-8.26"	Roller Tip	115 lbs.
32-860	32" Swing Variable Speed Lathes	7.8"-14.9"	Roller Tip	125 lbs.
32-861	32" Swing Variable Speed Lathes	1.78"-19.69"	Roller Tip	145 lbs.

FOLLOWER REST

The follower rest mounts on the carriage and moves with it, providing workpiece support close to the cutting tool, making it ideal for long slender parts which must be machined between models.



Part No.	Fits Lathe Models	Capacity Min-Max	Fingers	Weight
3-514	13" Swing Geared Head Lathes	0.375"-3"	Bronze	16 lbs.
13-471VS	13" Swing Variable Speed Lathes	0.375"-3"	Bronze Tip & Roller	16 lbs.
15-754N	15" Swing Geared Head & Variable Speed Lathes	0.375"-6.375"	Bronze Tip & Roller	28 lbs.
18-811	18" Swing Variable Speed Lathes	0.375"-9.375"	Bronze Tip & Roller	37 lbs.
21-411VS	21" Swing Variable Speed Lathes	0.375"-4.25"	Bronze Tip & Roller	37 lbs.
26-411VS	26" Swing Variable Speed Lathes	0.79"-6.3"	Roller Tip	40 lbs.
32-411VS	32" Swing Variable Speed Lathes	0.79"-6.3"	Roller Tip	45 lbs.

ALORIS QUICK CHANGE TOOL POST

Precision engineered to ensure accuracy. Advanced design provides built-in quick tool changing versatility with high rigidity to meet the most exacting working tolerance. Quickly and easily installed on any engine or bench lahte, for a wide range of operations, from fine precision work to heavy-duty cutting.

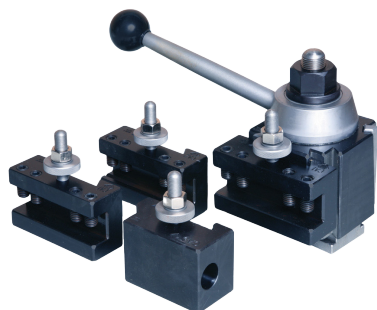

The Aloris Quick Change Tool Post is shipped with four (4) tool holders: 2 turning and facing holders; 1 boring, turning and facing Holders; 1 morse taper holder.

Part No.	Fits Lathe Models	Weight
3-503A	13" Swing Geared Head Lathes	29 lbs.
13-775A	13" Swing Variable Speed Lathes	32 lbs.
15-775A	15" Swing Geared Head & Variable Speed Lathes	35 lbs.
17-875A	18" Swing Variable Speed Lathes	69 lbs.
21-475A	21" Swing Variable Speed Lathes	69 lbs.
26-475A	26" Swing Variable Speed Lathes	69 lbs.
32-475A	32" Swing Variable Speed Lathes	69 lbs.

ALORIS TOOL POST EXTRA TOOL HOLDERS

These holders are for the 15-775A tool post. Other model numbers listed in price sheets.

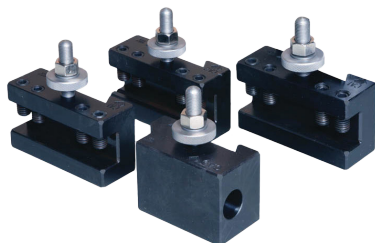

Part No.	Holder Type
15-775A-1	Aloris Extra Straight Holder 1"
15-775A-2	Aloris Extra V-Holder 1", 0.825" Boring Bar
15-775A-4D	Aloris 1.25" Boring Bar Holder
15-775A-41D	Aloris 1.5" Boring Bar Holder
15-775A-5	Aloris Extra 3MT Holder
15-775A-71	Aloris Extra Cutoff Holder 2" Height
15-77A-BSL-187	Aloris Cutoff Blade Self-Locking Throw Away 1.875"

FIVE POSITION CARRIAGE STOP

This stop is useful for turning multiple diameter work and is mounted on the apron. Each of the five screw stops can be indexed to contact the stop pin mounted on the bed vee. Accurate indexing is provided by a steel ball under spring tension.

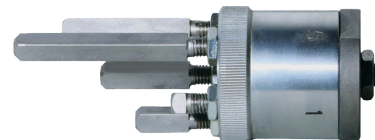

Part No.	Fits Lathe Models	Weight
3-518	13" Swing Geared Head Lathes	29 lbs.
14-438VS	13" & 15" Swing Geard Head & Variable Speed Lathes	32 lbs.
18-831	18" & 21" Swing Variable Speed Lathes	35 lbs.
26-831	26" Swing Variable Speed Lathes	69 lbs.
32-831	32" Swing Variable Speed Lathes	69 lbs.

ONE POSITION CARRIAGE STOP

This hardened stop clamps on the front bed way at any position determined by the operator, allowing repetitive cuts to the same position.



Part No.	Fits Lathe Models	Weight
3-516	13" Swing Geared Head Lathes	2 lbs.
13-435VS	13" & 15" Swing Geard Head & Variable Speed Lathes	3 lbs.
17-832	18" & 21" Swing Variable Speed Lathes	5 lbs.

MICRO POSITION CARRIAGE STOP

This hardened stop clamps on the front bed way at any position determined by the operator, allowing repetitive cuts to the same position.



Part No.	Fits Lathe Models	Weight
3-517	13" Swing Geared Head Lathes	2 lbs.
13-436VS	13" & 15" Swing Geard Head & Variable Speed Lathes	3 lbs.
17-833	18" & 21" Swing Variable Speed Lathes	5 lbs.
26-833	26" Swing Variable Speed Lathes	5 lbs.
32-833	32" Swing Variable Speed Lathes	5 lbs.

The Last Word in Toolroom Lathe Productivity – Pick from One of These Three World Leading Digital Readout Systems.



ACU-RITE SOLUTIONS



LATEST GENERATION ACU-RITE SOLUTIONS DIGITAL READOUT

The ultimate in efficiency and turning productivity, utilizing state-of-the-art features:

- Simplify cutting metric threads on lathes with inch leadscrews with thread assist function
- 16 Tool offsets for easy compensation of different tool sizes
- Lock axis feature, used in conjunction with tool offsetting, lets the operator establish tool offsets with the tool under load, resulting in reduced deflection.
- Instant radius/diameter conversion reduces math errors and allows the operator to machine to print
- Position trac; a unique feature that lets you easily, quickly and accurately re-establish workpiece zero after power loss
- 2, 3 or 4-axes readout flat-screen LCD display
- Preset and zero reset
- Near-zero warning
- Instant inch/mm conversion
- Linear and non-linear error compensation
- Taper calculator
- Die-cast metal construction
- Multiple program names with numerous steps
- Multiple display views
- Feed rate display
- Advanced skew compensation
- Multiple language supports
- Absolute/incremental
- Help function

For current model and features please check ACU-RITE Solutions' website here: www.acu-ritesolutions.com

NEWALL

LATEST GENERATION NEWALL DIGITAL READOUT

Newall DRO's are powerful and intuitive, and are housed in a rugged, ergonomically designed casting. The DRO features all of the essential functions for turning.



- Solid cast construction
- Long life membrane keypad
- Crisp LEDs
- Intuitive message window
- Wide viewing angle
- Safe, low voltage external power supply
- Five year warranty
- Customized canned cycles
- ABS/Inch
- Metric/Inch
- Zero approach
- Tool offsets
- Taper
- Summing
- Polar coordinates
- Line hole
- Programmable memory
- Feed-rate display
- Linear and segmented error compensation

For current model and features please check Newalls' website here: www.sensata.com

FAGOR



LATEST GENERATION FAGOR DIGITAL READOUT

Fagor's Digital Readout (DRO) systems offer a user-friendly solution for improving precision and efficiency in machining operations. With intuitive controls, clear displays, and advanced features like tool offsets and measurement modes, Fagor DROs ensure operators can achieve accurate results consistently.



- Color LCD display
- High clarity view from any angle
- Solid graphics & 3D simulation
- Conversational graphic help screen
- Friendly and intuitive operation
- Easy set-up and diagnosis
- Up to 16 tool offsets
- Built-in calculator with auto recall
- Feedback alarms
- Taper calculation
- Software travel limits for safety
- Reset, pre- et, direct mm/ inch conversion
- Fagor warranty: 3 years and lifetime on glass

For current model and features please check Fagors' website here: www.fagorautomation.com

PRATT BURNERD SELF-CENTERING UNIVERSAL 3-JAW SETRITE CHUCKS



Pratt Burnerd Universal Setrite 3-Jaw Chucks are precision manufactured with a .0005 T.I.R. repeatability on duplicate parts. The steel body allows high metal removal rates. 3-Jaw Setrite Chucks are supplied with two-piece American standard tongue and groove reversible jaws. Chucks have nitride hardened scroll and hardened pinion. All chucks have a two year warranty.

Part No.	Dia.	Lathe Type and Size	Spindle Size	Max RPM	Weight
0625321	6"	13" Swing Geared Head & Variable Speed Lathes	D1-4	4900	26 lbs.
0825321	8"	13" Swing Geared Head & Variable Speed Lathes	D1-4	4200	46 lbs.
0825323	8"	15" Swing Geared Head & Variable Speed Lathes	D1-6	4200	46 lbs.
1025323	10"	15" Swing Geared Head & Variable Speed Lathes	D1-6	3300	71 lbs.
1025324	10"	18" Swing Variable Speed Lathes	D1-8	3300	71 lbs.
1225324	12"	18" Swing Variable Speed Lathes	D1-8	2300	112 lbs.
1225325	12"	21" Swing Variable Speed Lathes	D1-11	2300	112 lbs.
1525325	15"	21" Swing Variable Speed Lathes	D1-11	2000	146 lbs.

PRATT BURNERD SELF-CENTERING UNIVERSAL 6-JAW SETRITE CHUCKS



Pratt Burnerd Universal Setrite 6-Jaw Chucks are precision manufactured with a .0005 TIR repeatability on duplicate parts. The steel body allows high metal removal rates. 6-Jaw Setrite Chucks are supplied with two-piece American standard tongue and groove reversible jaws. Chucks have nitride hardened scroll and hardened pinion. All chucks have a two year warranty.

Part No.	Dia.	Lathe Type and Size	Spindle Size	Max RPM	Weight
0626321	6"	13" Swing Geared Head & Variable Speed Lathes	D1-4	3500	27 lbs.
0826321	8"	13" Swing Geared Head & Variable Speed Lathes	D1-4	3000	49 lbs.
0826323	8"	15" Swing Geared Head & Variable Speed Lathes	D1-6	3000	49 lbs.
1026323	10"	15" Swing Geared Head & Variable Speed Lathes	D1-6	2400	76 lbs.
1026324	10"	18" Swing Variable Speed Lathes	D1-8	2400	76 lbs.
1226324	12"	18" Swing Variable Speed Lathes	D1-8	2000	116 lbs.
1226325	12"	21" Swing Variable Speed Lathes	D1-11	2000	116 lbs.
1526325	15"	21" Swing Variable Speed Lathes	D1-11	1500	205 lbs.

PRATT BURNERD 4-JAW MEDIUM DUTY INDEPENDENT CHUCKS



Pratt Burnerd Independent Chucks are precision manufactured and supplied with ductile iron bodies, hardened operating screws and solid reversible hard jaws. Special jaw and jaw way design adds extra bearing surfaces, increasing chuck life and rigidity. Pratt Burnerd Independent Chucks come with a two year warranty.

Part No.	Dia.	Lathe Type and Size	Spindle Size	Weight
0814421	8"	13" Swing Geared Head & Variable Speed Lathes	D1-4	31 lbs.
1014421	10"	13" Swing Geared Head & Variable Speed Lathes	D1-4	43 lbs.
1014423	10"	15" Swing Geared Head & Variable Speed Lathes	D1-6	43 lbs.
1214423	12"	15" Swing Geared Head & Variable Speed Lathes	D1-6	72 lbs.
1214424	12"	18" Swing Variable Speed Lathes	D1-8	72 lbs.
HEAVY DUTY CHUCKS				
1414524	14"	18" Swing Variable Speed Lathes	D1-8	126 lbs.
1614525	16"	21" Swing Variable Speed Lathes	D1-11	180 lbs.
1843-2AD11	18"	26" Swing Variable Speed Lathes	D1/A11	320 lbs.
2043-2AD11	20"	32" Swing Variable Speed Lathes	D1/A11	415 lbs.
2443-2AD11	24"	32" Swing Variable Speed Lathes	D1/A11	720 lbs.
2443-2AD11	24"	32" Swing Variable Speed Lathes	D1/A11	720 lbs.

5C FRONT MOUNTED HAND WHEEL SPEED COLLET CHUCK

Fast and easy, front hand wheel operation reduces operator fatigue with accurate maximum cone T.I.R. 0.0005". Easy installation, no draw tubes or linkages required. One year warranty.



Part No.	Lathe Type & Size	Spindle	Weight
PB23-D4	13" Swing Variable Speed Lathes	D1-4	15 lbs.
PB23-D6	15" Swing Geared Head & Variable Speed Lathes	D1-6	17 lbs.
PB23-D8	18" Swing Variable Speed Lathes	D1-8	23 lbs.
PB23-D11	21" Swing Variable Speed Lathes	D1-11	27 lbs.

16C FRONT MOUNTED HAND WHEEL SPEED COLLET CHUCK

Fast and easy, front hand wheel operation reduces operator fatigue with accurate maximum cone T.I.R. 0.0005". Easy installation, no draw tubes or linkages required. One year warranty.



Part No.	Lathe Type & Size	Spindle	Weight
PB16-D4	13" Swing Variable Speed Lathes	D1-4	36 lbs.
PB16-D6	15" Swing Geared Head & Variable Speed Lathes	D1-6	38 lbs.
PB16-D8	18" Swing Variable Speed Lathes	D1-8	44 lbs.
PB23-D11	21" Swing Variable Speed Lathes	D1-11	52 lbs.

5C FRONT MOUNTED HAND WHEEL SPEED COLLET CHUCK

No hydraulic system required. No draw tube or air feed tubes restricting spindle bore. No rear cylinders and cylinder adapters. Easily convert any lathe into a production machine. Repeats on duplicate parts \pm 0.00015.



Part No.	Lathe Type & Size	Spindle	Weight
ATL206-5CD4	13" Swing Variable Speed Lathes	D1-4	22 lbs.
ATL206-5CD6	15" Swing Geared Head & Variable Speed Lathes	D1-6	22 lbs.
ATL206-5CD8	18" Swing Variable Speed Lathes	D1-8	22 lbs.

AIR POWERED FRONT MOUNTED B42 DEAD LENGTH COLLET

No hydraulic system required. No draw tube or air feed tubes restricting spindle bore. No rear cylinders and cylinder adapters. Easily convert any lathe into a production machine. Repeats on duplicate parts \pm 0.00015.



Part No.	Lathe Type & Size	Spindle	Weight
ATL207-B42D4	13" Swing Variable Speed Lathes	D1-4	35 lbs.
ATL206-B42D6	15" Swing Geared Head & Variable Speed Lathes	D1-6	35 lbs.
ATL206-B42D8	18" Swing Variable Speed Lathes	D1-8	35 lbs.

AIR POWERED FRONT MOUNTED 16C DEAD LENGTH COLLET

No hydraulic system required. No draw tube or air feed tubes restricting spindle bore. No rear cylinders and cylinder adapters. Easily convert any lathe into a production machine. Repeats on duplicate parts \pm 0.00015.



Part No.	Lathe Type & Size	Spindle	Weight
ATL207-16CD4	13" Swing Variable Speed Lathes	D1-4	30 lbs.
ATL207-16CD6	15" Swing Geared Head & Variable Speed Lathes	D1-6	30 lbs.
ATL207-16CD8	18" Swing Variable Speed Lathes	D1-8	30 lbs.

AIR POWERED FRONT MOUNTED B60 DEAD LENGTH COLLET

No hydraulic system required. No draw tube or air feed tubes restricting spindle bore. No rear cylinders and cylinder adapters. Easily convert any lathe into a production machine. Repeats on duplicate parts \pm 0.00015.



Part No.	Lathe Type & Size	Spindle	Weight
ATL208-B60D4	13" Swing Variable Speed Lathes	D1-4	46.6 lbs.
ATL208-B60D6	15" Swing Geared Head & Variable Speed Lathes	D1-6	46.6 lbs.
ATL208-B60D8	18" Swing Variable Speed Lathes	D1-8	46.6 lbs.

SLOTTED FACE PLATE

Part No.	Dia.	Lathe Type and Size	Spindle Size	Weight
13-403	12"	13" Swing Variable Speed Lathes	D1-4	45 lbs.
13-500	12"	13" Swing Geared Head Lathes	D1-4	45 lbs.
13-404	18"	13" Swing Variable Speed Lathes	D1-4	60 lbs.
13-502	18"	13" Swing Geared Head Lathes	D1-4	60 lbs.
15-703	14"	15" Swing Geared Head & Variable Speed Lathes	D1-6	50 lbs.
15-704	21"	15" Swing Geared Head & Variable Speed Lathes	D1-6	108 lbs.
17-803	17"	18" Swing Variable Speed Lathes	D1-8	120 lbs.
17-804	28"	18" Swing Variable Speed Lathes	D1-8	229 lbs.
21-403	20"	21" Swing Variable Speed Lathes	D1-11	130 lbs.
21-404	27"	21" Swing Variable Speed Lathes	D1-11	205 lbs.

CRAWFORD 16C ROUND COLLETS



Part No.	Sizes
G119-R (R=Size)	0.0625" thru 1.625" by 16ths

CRAWFORD B-42 ROUND COLLETS



Part No.	Sizes
4728-R (R=Size)	0.0625" thru 1.653" by 16ths

CRAWFORD B-60 ROUND COLLETS



Part No.	Sizes
4291-R (R=Size)	0.0625" thru 2.362" by 16ths

CRAWFORD 5C ROUND COLLETS



Part No.	Sizes
0123-R (R=Size)	0.125" thru 1.125" by 64ths
5C Round Collet Sets	
0123-SET-4	0.0625" thru 1.0625" by 64ths
0123-SET-5	0.0625" thru 1.0625" by 32nds
0123-SET-6	0.0625" thru 1.0625" by 16ths
0123-SET-7	0.125" thru 1" by 8ths
7659	Collet Rack for 13" and 15" lathes



Clausing Industrial

Clausing Industrial, LLC.
Kalamazoo, Michigan
Phone: 269-345-7155
Fax: 269-345-5945
Information: info@clausing-industrial.com
Website: www.clausing-industrial.com



An InCompass™ Brand



manufacturedgrowthsolutions.com